

# 19" Smart TV

---

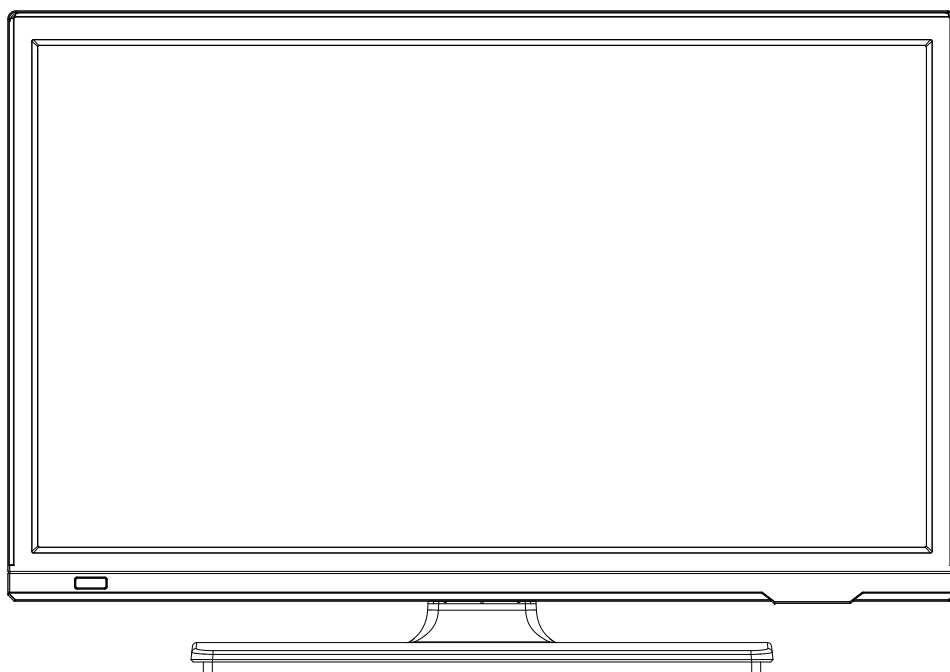

## INSTRUCTION MANUAL

## **Contents:**

Preface/ Whats in the box/ Fixing the stand feet .....	3
Wall mounting/ Front IR sensor and TV buttons .....	4
Rear view connections .....	5
Remote control .....	6-8
Video and Audio connections/ Connecting AV with HDMI .....	9
Connecting digital audio device/ Connecting a USB storage device .....	10-11
Power on the TV for the first time .....	11
First time installation wizard .....	12
Reset to factory default/ Select source/ Channel selection options .....	13-14
Picture options .....	14
Sound options/ Channel setup .....	15-17
Function menu .....	17-18
Setup menu .....	18
Smart features .....	22-24
DVD Operation.....	25-27
Maintenance/ Trouble shooting .....	28
Technical Specifications .....	29
Safety warnings .....	29-32

## **Preface:**

Thank you for choosing our 19" Smart TV. This TV has many features and incorporates the latest technology to enhance your viewing experience. We recommend that you spend some time reading this instruction manual in order that you fully understand these features. Read all of the safety instructions carefully before use and keep this instruction manual for future reference.

### **Whats in the box:**

- TV
- Stand & Stand fixing Screws ((ST4 x 10) x3)
- Power Adapter
- Remote control
- Batteries (2 x AAA)
- Quick start guide
- Warranty card

### Fixing and the TV stand feet

Place the TV face down on a soft and flat surface (blanket, foam, cloth, etc.) to prevent any damage to the TV.

1. Attach the stand feet in the positions shown below and secure them with supplied screws ((ST4 x 10) x 3)

## **Fixing the TV stand feet**

Place the TV face down on a soft and flat surface (blanket, foam, cloth, etc.) to prevent any damage to the TV.

1. Attach the stand feet in the positions shown below and secure them with supplied screws ((ST4 x 10) x 3)

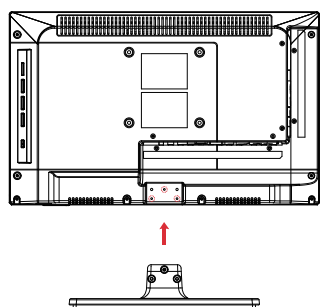

## Wall mounting:

This TV is VESA-Compliant and has been designed to be wall mounted with a VESA-Compliant wall mounting kit. (Wall mounting kit and screws not included)

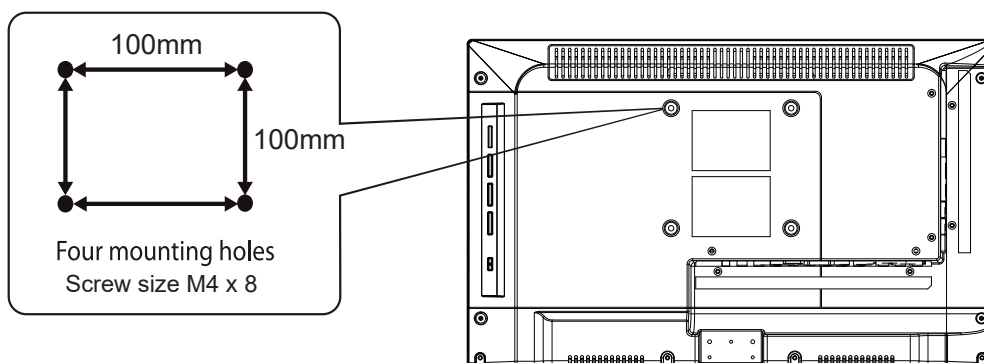

## Front IR sensor and TV buttons

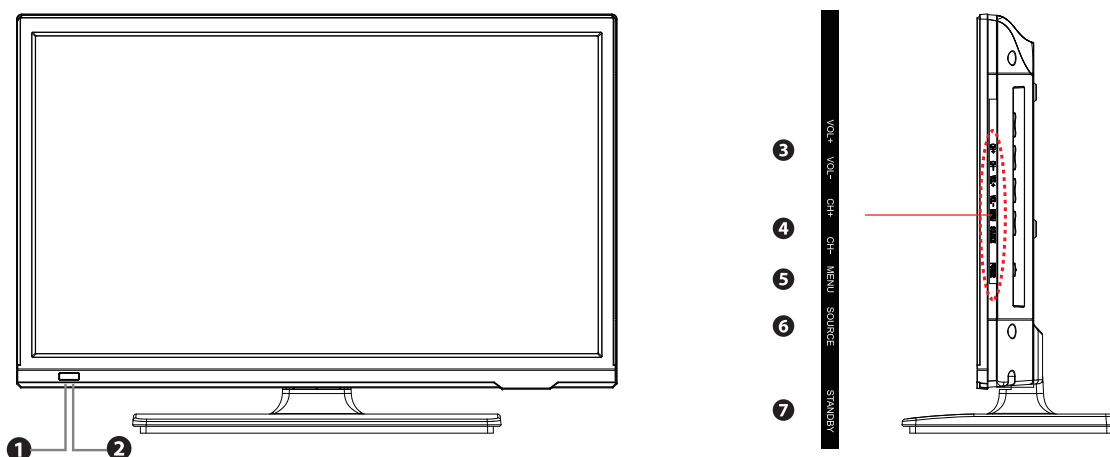

1	IR (Infrared Receiver)	Receives IR signals from the remote control. Do not put anything near the sensor, as its function may be affected.
2	Power LED	Illuminates green when the TV is turned on. Illuminates red when the TV is in standby mode. The LED will alternate between red and green when the RECTimer programming has started in standby mode.
3	VOL +/-	Adjust the volume
4	CH +/-	Select channels
5	MENU	Displays the on-screen Menu options
6	SOURCE	Select input source (HDMI1, HDMI2, HDMI3, HDMI4, AV)
7	STANDBY	Switches the TV ON/OFF from and to Standby mode

## Rear View and Connections

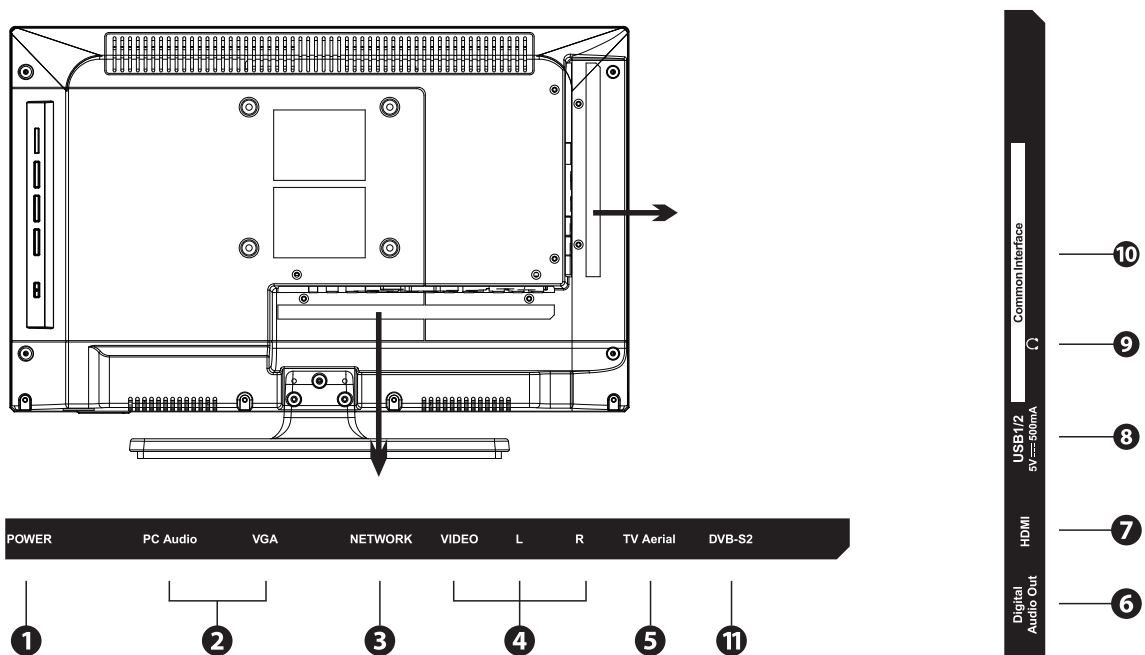

1	Power	To connect to power supply
2	VGA/PC Audio	To connect to a computer or other devices with a VGA interface
3	Network	RJ45 connector to connect between the TV and internet Router
4	AV	Connect devices with composite video and audio outputs
5	TV Aerial	Connect the TV aerial
6	Digital Audio out	Connect an Optical audio cable
7	HDMI	Connect HDMI sockets on devices such as game consoles and DVD player
8	USB	Play video audio and text files and use as storage for recordings
9	Headphone	Headphone/Earphone connector
10	Common Interface	Allows the insertion of the a Common Access Module

## Remote control:

Dependant on the model of TV, some keys will have no function

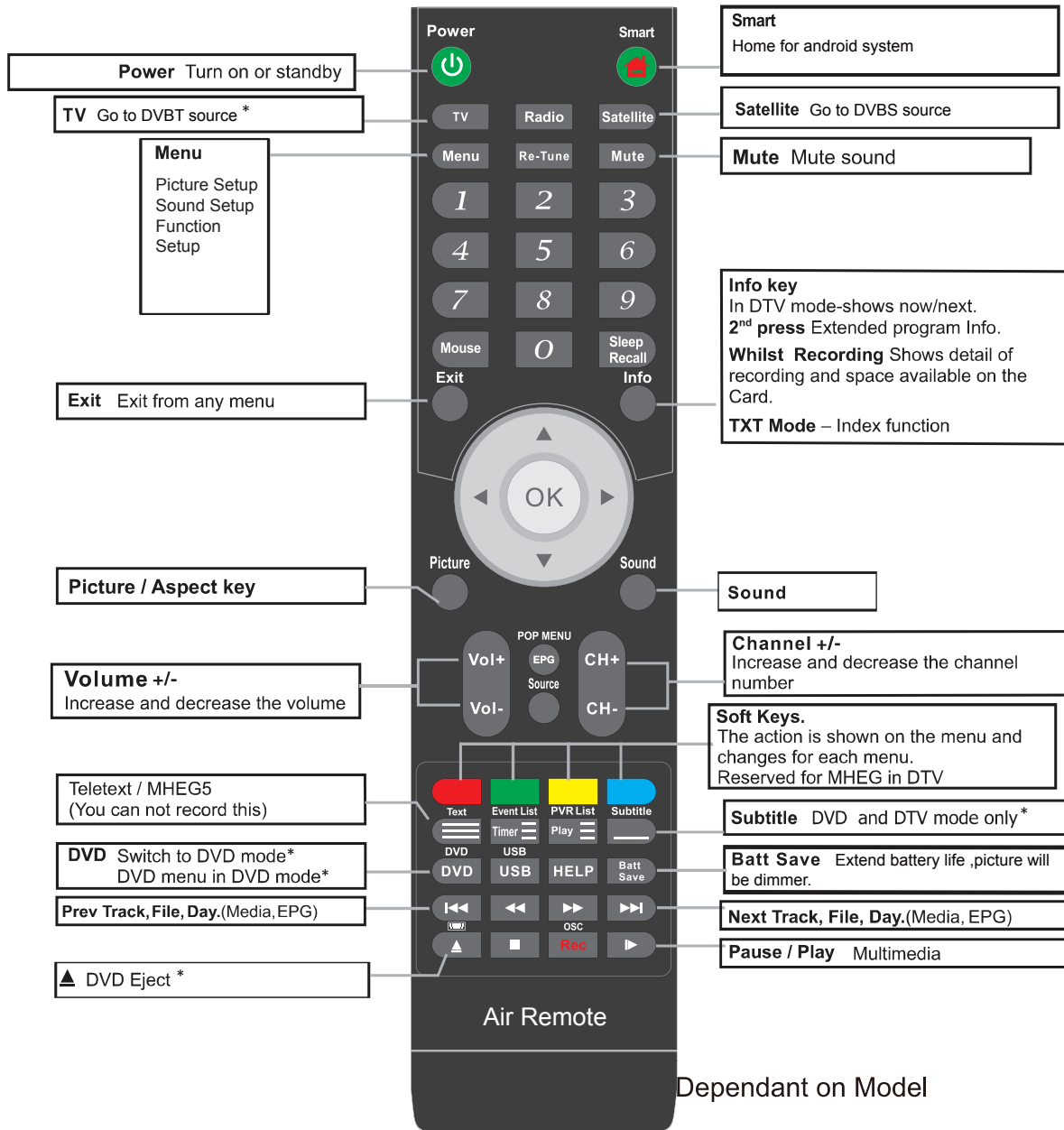

## Remote control:

Dependant on the model of TV, some keys will have no function

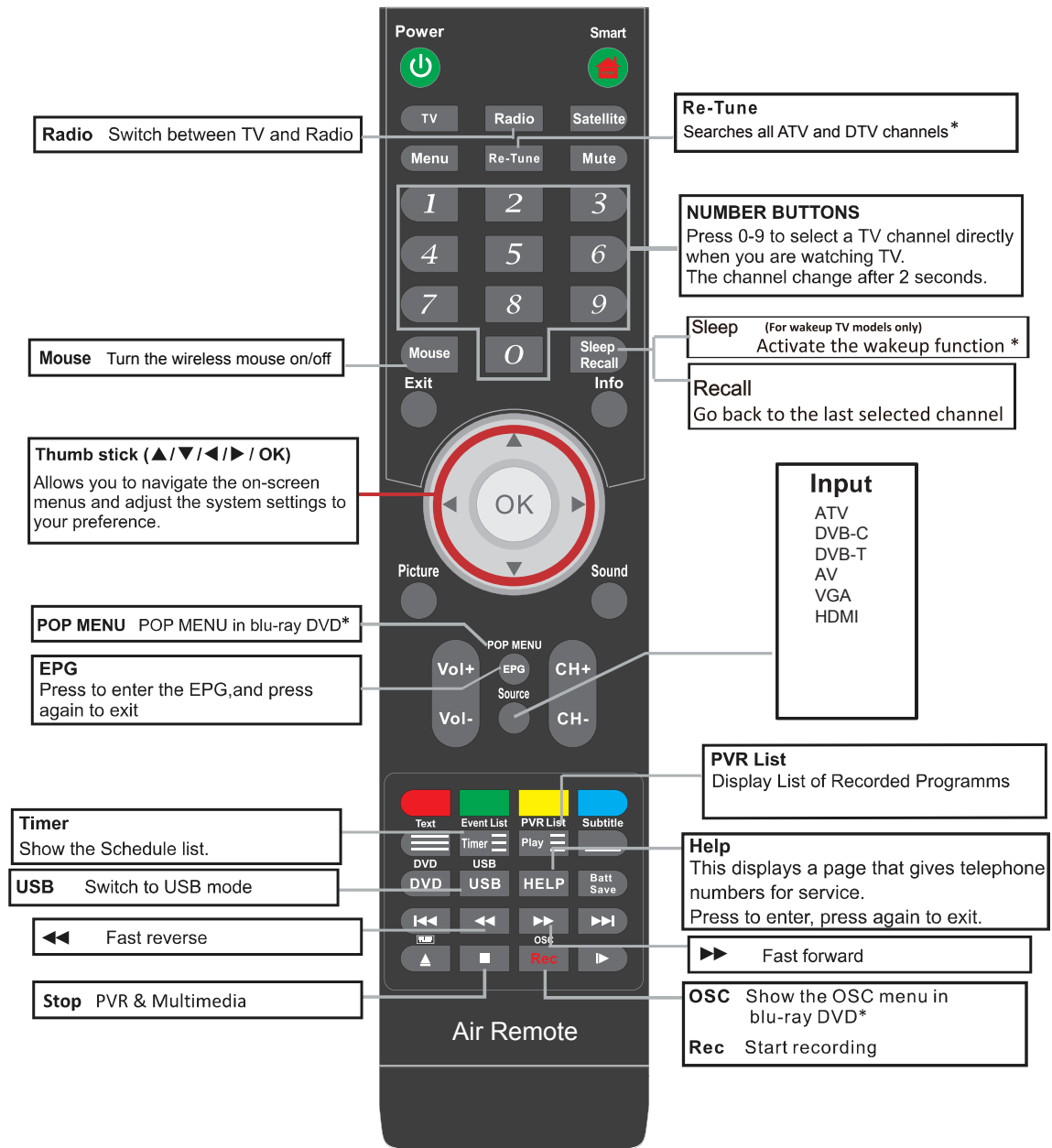

\*Dependant on Model

The Mouse cursor is turned on and off by pressing the Mouse key.

### Installing Batteries into the Remote Control

Plug in the TV and wait for the TV to power on and show a picture on the screen before inserting the batteries. This enables the wireless remote control to pair correctly with the TV.

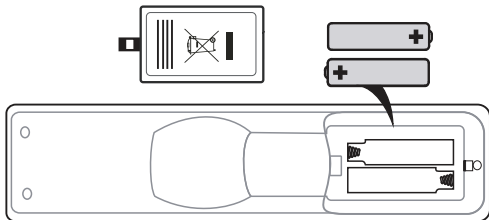

1. Insert 2 x 1.5V AAA batteries making sure to match the (+) and (-) ends of the batteries with the (+) and (-) ends shown in the batterie compartment.
2. Close the batterie compartment cover.

### The Remote-Control Operation Range

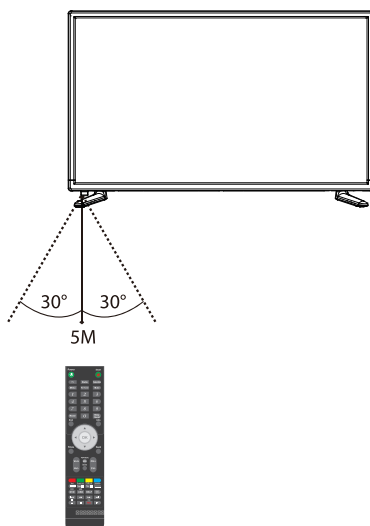







5 Meters is the normal distance recommended between the Remote control and the TV IR sensor and within 60° in front of the TV (See diagram). The operating distance may vary depending on the brightness of the room.



## Video and Audio Connections

This TV supports High-Definition Multimedia Interface (HDMI) and High-Bandwidth Digital Content Protection (HDCP) Protocol.

Best Video Performance ↑		Signal Type	Seperate Audio Connection Required
	 HDMI	HDMI (480i/480p/576i/576p/720p/1080i/1080p)	No
	 VGA	PC	Yes  PC AUDIO
	 Mini YPbPr	Component Video (480i/480p/576i/576p/720p/1080i/1080p)	Yes  Mini AV
	 Mini AV	Composite Video	No

Always connect a device to the TV with the highest quality connection available. Also, use good quality cables to ensure a good transfer of picture and sound. An HDMI connection has the best picture and sound quality. One HDMI cable combines video and audio signals.

## Connecting an AV device with an HDMI cable

Audio/Video devices:

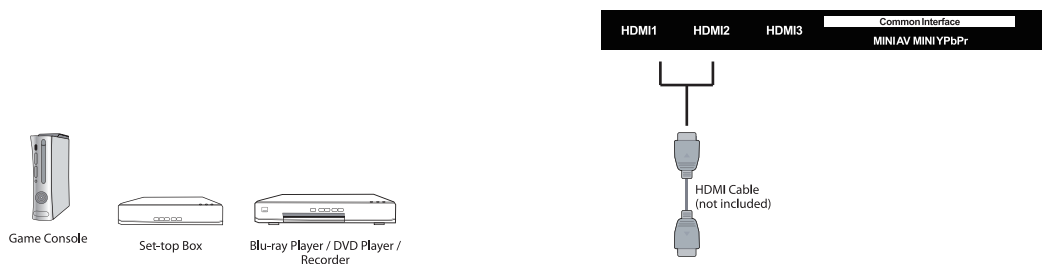

After connecting to an external device (Blu-ray disc player, Game console, Set-top box, or personal computer) with the HDMI cable. Select the HDMI in the source menu and the TV will automatically detect the resolution coming from the device. For the best picture quality adjust the device output resolution up to 3840 x 2160p.

## Connecting a Digital Audio Receiver

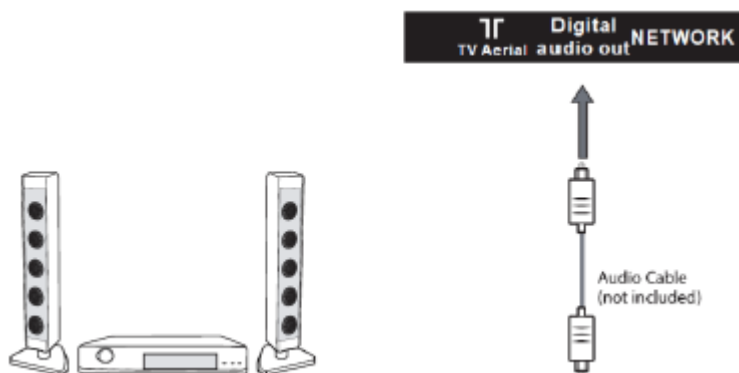

For a better sound quality, you may want to listen to the TV audio output through your Home Sound System or Sound bar. The TV is fitted with an Optical Digital Audio Output. When purchasing a cable, it must be an Optical cable. When the Optical cable is connected to both devices select the source mode optical on the Sound system or Sound bar.

## Connecting a USB Storage Device

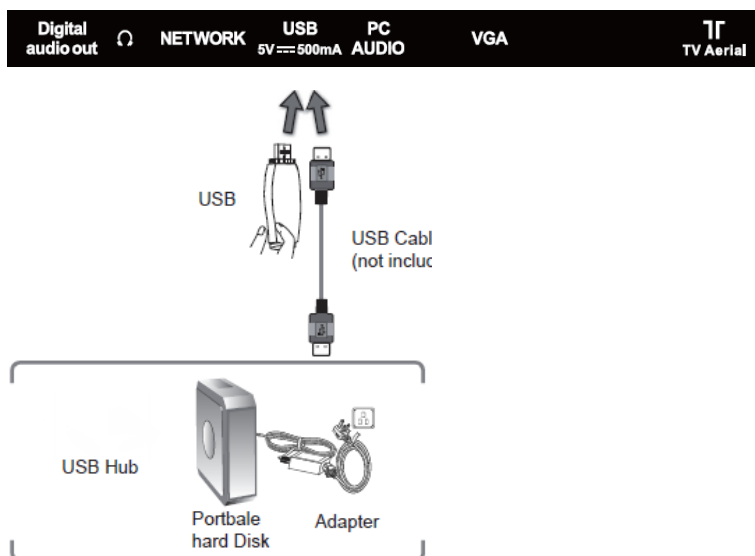

1. Switch off the TV before connecting any USB device
2. Connect the USB storage device to the USB power of the TV
3. Press the power button on the TV or the power key on the remote control to turn the TV on.
4. Press the smart key on the remote control to show the smart home screen. In the source options select Media to view files on the USB device.

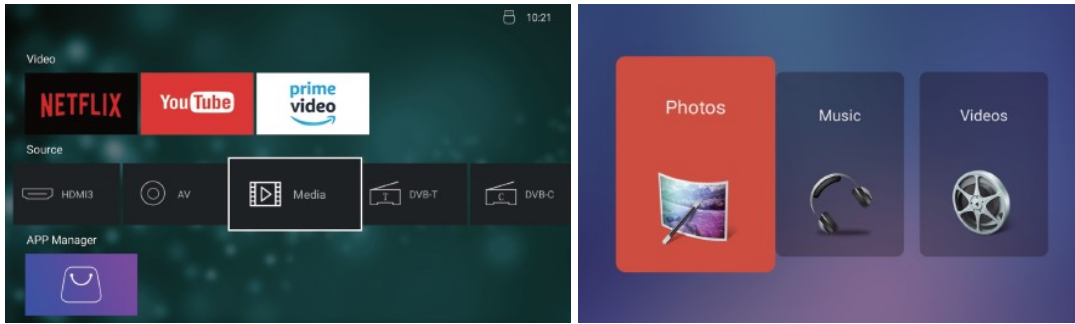

- If a hard disk is used, make sure its mains adapter is connected to the mains supply.
- If a USB hub is used, make sure its mains adapter is connected to the mains supply as the total current consumption may exceed 500mA.
- The maximum tested supported storage space of the hard disk is 1TB.
- The file system only supports Hi-Speed FS, FAT16, FAT32, NTFS formats (NTFS Compressed files are not supported).
- If you want to store the video streaming of a DTV programme, the transfer rate of the USB storage device must not be less than 5MB/s, otherwise the picture and sound of the programme will be affected and a warning message will be shown on the screen. If this happens, please upgrade your USB storage device.
- Disconnect the USB storage device if it is not in use.
- USB output: DC 5V 500mA

### **Powering on the TV for the first time**

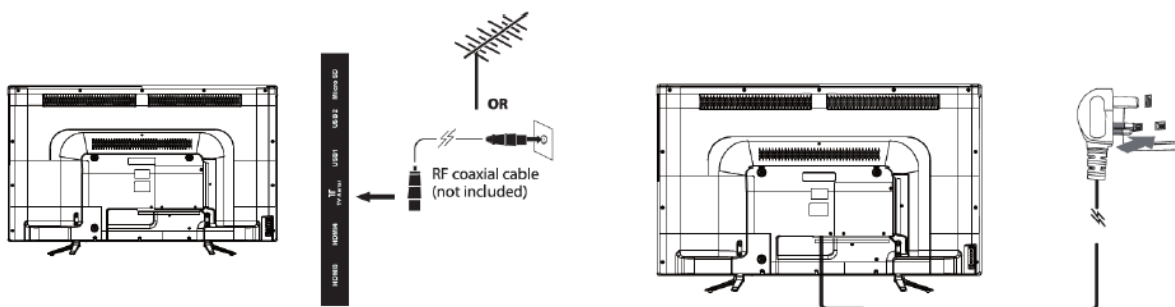

Connect the TV aerial to the TV aerial (RF) connector on the TV and to the TV house aerial connector on the wall.

Connect the TV to the house mains supply with the 3-pin plug. Turn on the TV by pressing the Power key on the remote control or the Standby button on the TV.

So that the wifi remote connects correctly with the TV point the remote control at the TV and insert the batteries. The red led light on the remote control will flash red for a few seconds then you will see the air mouse cursor on the screen. The mouse can be turned on and off by pressing the mouse key on the remote control.

## First-time Start up Installation Wizard

It is recommended to turn the mouse cursor off and use the OK key and navigation keys on the remote control to quickly manoeuvre through the Wizard. The Wizard is defaulted to UK settings.

Note all options are selected by pressing the right-side navigation key on the remote control.



1. Language
2. Time zone
3. Network (All WIFI options will be shown on the screen. Select the one you want and if applicable type in the password to activate, once connected continue with the right-side navigation key)  
**NOTE: After typing in the password use the remote mouse cursor to click on “connect” to the WIFI.**

If the ethernet cable is connected to the RJ45 socket the TV will connect automatically.

4. Home (This is the typical and recommended power saving setting)
5. The Welcome screen offers two options

a) Start TV tuning

b) Start Launcher (Smart home screen)

If **Start TV** is selected scroll down and select DIGITAL AUTO TUNING, press the OK key and the TV tuning will begin.

If Start Launcher is selected the TV tuning will be skipped and the smart launcher homes screen will show.

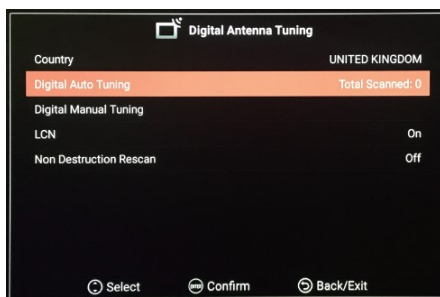
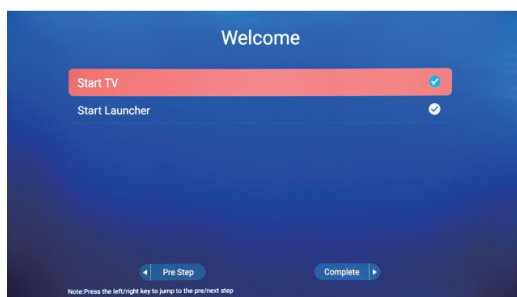

## **Reset the TV to factory default**

If at a later date you wish to reset the TV to factory default settings. **(Please be aware that this option will delete all of your preloaded apps and settings)**

Press the smart key on the remote control to return to the launcher home screen then select the System Settings icon. Then select the option Common.

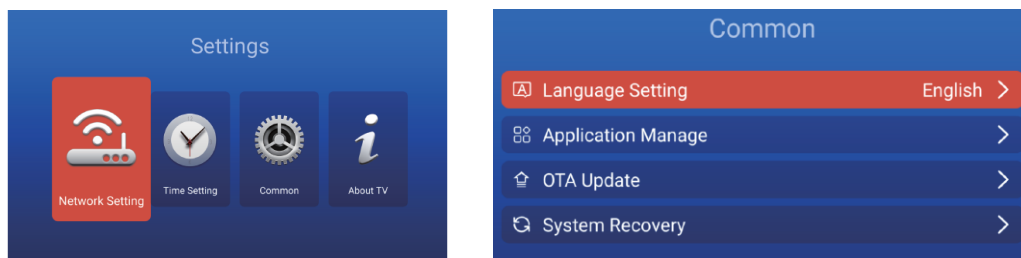

Scroll down and select the option System Recovery, now select Factory Data Reset everything. The TV will restart with the First-time Installation Wizard.

## **Selecting the Input Source**

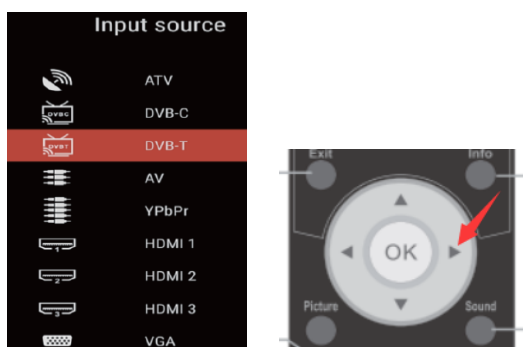

1. Press the Source button on the TV or the Source key on the remote control to display the input source list.  
Press the up/down navigation keys on the remote control to select the input source that you want. Choose from: ATV, DVB-C, DVB-T, AV, YPbPr, HDMI 1/2/3, VGA.
2. Press the OK key on the remote control to confirm your selection.

## **Channel selection options**

1. Use the Ch+/- key on the remote control to go up and down the channels
2. Type in the channel numbers using the numeric keys on the remote control. The number being typed in will appear top left of your screen in red. After a few seconds the TV will tune to the chosen channel. This process can be accelerated by pressing the OK key on the remote control after the channel number is on the screen.
3. Press the OK key on the remote control to display the channel list. Using the up/down navigation keys on the remote control to scroll to the channel you require. Press the OK key on the remote control to activate.

## Display Channel Information

1. Press the Info key on the remote control to display the channel information.

## Volume Adjustment

1. Press the Vol+/- key on the remote control to increase and decrease the volume on the TV.
2. Press the Mute key on the remote control to turn off the sound completely. Once the sound is muted. Press the Mute key or the Vol+ key on the remote control to deactivate the mute function.

## Picture Options in DVB-T mode (Television)

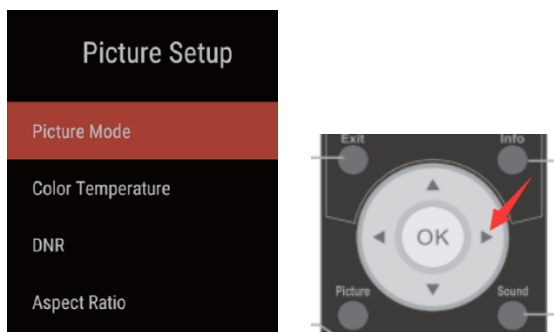

**To navigate all menus, use the up/down/left right navigation keys on the remote control. Press the EXIT key on the remote control to return to previous menu.**

1. Press the menu key on the remote control to activate the main menu
2. Select Picture setup and activate with the OK key on the remote control
3. **Picture mode:** Select from Standard/Dynamic/Mild/User
4. **Colour Temperature:** Select from
  - Normal
  - Cool (Increases blue tint)
  - Warm (Increases red tint)
5. **DNR:** Select from Off/Low/Middle/High/Auto
6. **Aspect Ratio:** Select from 4:3/16:9/Auto/Zoom1/Zoom2

## Sound Options in DVB-T mode (Television)

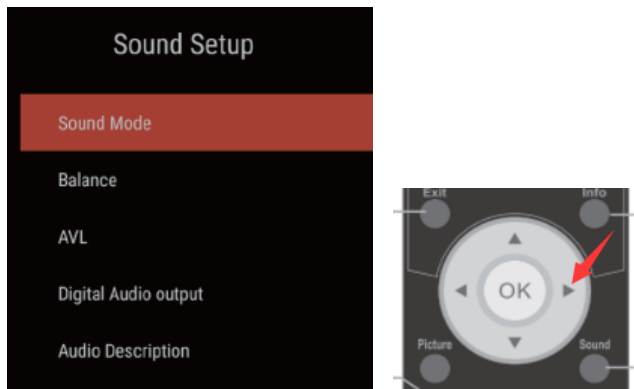

To navigate all menus, use the up/down/left right navigation keys on the remote control. Press the EXIT key on the remote control to return to previous menu.

1. Press the menu key on the remote control to activate the main menu
2. Select Sound setup and activate with the OK key on the remote control
3. **Sound Mode:** Select from Standard/Music/Movie/User
4. **Balance:** Using the left/right navigation key select your preference of audio balance
5. **AVL:** This feature automatically adjusts the audio level when the TV is turned on
6. **Digital Audio Output:** Select the spdif mode from OFF/PCM/Auto
7. **Audio Description:** Turn ON/OFF the Audio Description and set the Audio level

## Channel Setup (TV, DTV or Radio Mode)



To navigate all menus, use the up/down/left right navigation keys on the remote control. Press the EXIT key on the remote control to return to previous menu.

1. Select the **country** you are residing in

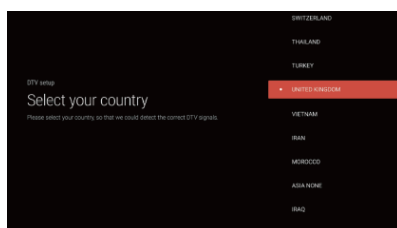

## 2. Select **Auto Scan** to re-tune the TV channels

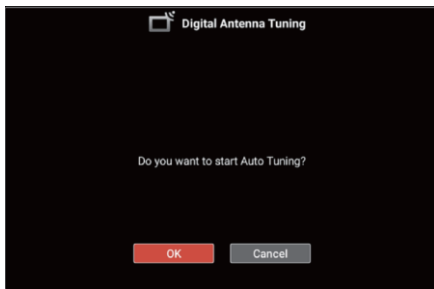

Press the OK Key on the remote control to start the TV channel tuning. Select Cancel to exit the Auto tune.

## 3. Select **DTV Manual Scan** to manually tune in TV channels



How to search Digital channels manually

**The TV channel signal strength and quality indicators are at the bottom of the picture**

- Select a channel number
- Select Start Scan to begin the manual search

## 4. **Channel Edit**

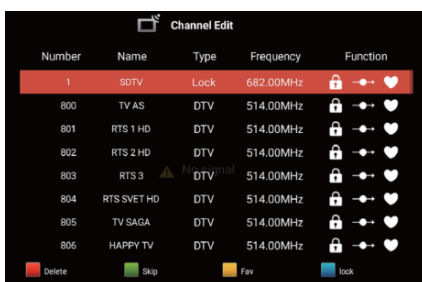

Edit all TV channels with the help of the edit options Delete/Fav/Skip/Lock

- Delete:** Press the red key on the remote control to delete a channel
- Fav:** Press the yellow key on the remote control to add the highlighted channel to the favourite list
- Skip:** Press the green key on the remote control to enable the skip function. If enabled the chosen channel will be skipped when scrolling through the channel list
- Lock:** Press the blue key on the remote control to lock the channel. The channel will be password protected



**Important note:** Lock feature needs to be activated and password set in the Function menu before the Lock feature can be used. Read Function options.

5. **Common Interface:** Displays Information of any inserted CI module (Card)
6. **DTV Setting**
  - a. **Subtitle language:** Select subtitle language
  - b. **Subtitle type:** Select from Normal or Hard of Hearing
  - c. **Audio type:** Select from Normal or Hard of Hearing
7. **Multi-Audio:** Select from the list of languages available

## Function

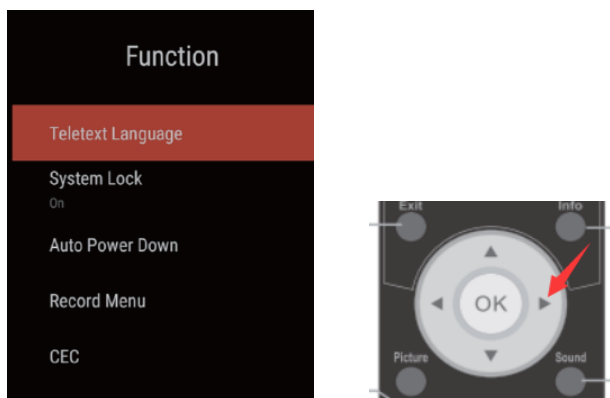

**To navigate all menus, use the up/down/left right navigation keys on the remote control. Press the EXIT key on the remote control to return to previous menu**

1. **Teletext language:** Select from West Europe/East Europe/Russian/Arabic
2. **System Lock:** Press the OK key on the remote control to turn the lock system on and off

**Important note:** The default password is 0000. After changing the password please make sure to remember it. If you do forget your password the override password is 8899

- a. **Change PIN:** Use this option to change your password
  - b. **Program restrictions:** This turns on the parental lock to set the age level of your choice to watch the channel. Select None to turn the parental lock off
3. **Auto Power Down:** The TV will power down if no activity on the TV or remote within the duration selected. Select from Off/1hr/2hr/3hr/4hr. The TV default setting is 4hr. Deactivate this function by selecting OFF
  4. **Record Menu**
    - a. **Record Disk Select:** Select the device used to record on
    - b. **Time-shift config:** Turn on/off the Time-shift function
    - c. **Start recording:** Start instant record, select from recording durations, 10min/30min/1hr/3hr/End when device is full/ End when programme ends
    - d. **Scheduled List:** View and edit scheduled recordings
    - e. **Recorded List:** View and playback available previous recordings

## 5. CEC

Various options to control HDMI ports: turn the CEC ON/OFF

### Setup

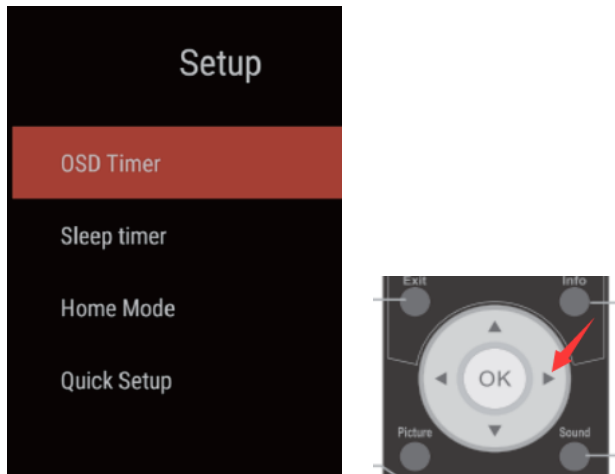

To navigate all menus, use the up/down/left right navigation keys on the remote control. Press the EXIT key on the remote control to return to previous menu

1. **OSD Timer:** Select options of the duration the menus remain on screen from 10s/20s/30s/40s/50s/60s/Off
2. **Sleep Timer:** The TV will automatically go to standby if the sleep timer is set. Select from options Off/15min/30min/60min/90min/120min/180min
3. **Home mode:** Select from Home/Max Brightness
4. **Quick Setup:** Reset the TV for TV tuning

## Dish Setup

To set a different Satellite or LNB.

1. Press the ▲▼ button to select Dish Setup , press ► key , navigate down to the Dish Setup option , press OK You will see the Satellite Dish Setup menu.
2. Press the Menu button to return back to the main menu.
3. Press the Exit button to exit the menu.

To set Multiple Satellites and LNBs (only possible on multi-LNB dish,switch systems)

Use ▲▼ buttons to select the satellite to which your dish is aligned. Press OK. An arrow will display against the chosen satellite.

Press ► button to navigate to LNB section of the menu.

Select the LNB type and settings for your LNB.

Press the Exit button and the ◀ button.

Press the blue Key twice to search the satellite channels.

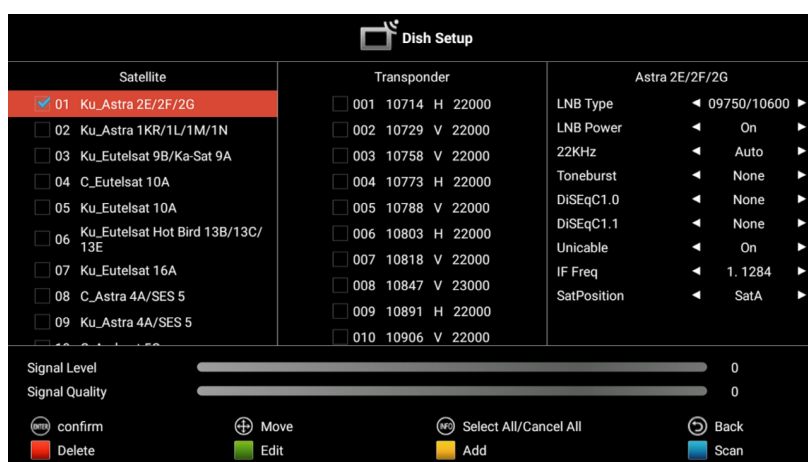

**A full description of the advanced Dish set up for multiple satellites using DiSEqC switches and DiSEqC positioner follows. This should only be attempted by experienced users.**

The Dish set up main menu page displays the main inter-face. The interfece consists of Satellite List, Transponder list and Dish/LNB parameter List.

Press the OK key on the remote control to confirm yo

## Satellite Edit

**No.:** The current list number of the selected satellite Satellite name. The No. cannot be edited.

**Satellite name:** Press the green button to open the edit menu.

**Longitude Direction:** Use the ◀ arrow buttons to select West/ East.

**Longitude Angle:** Input Longitude. Move the cursor to Longitude Angle and press the digits buttons to enter the satellite longitude.

**Band:** Band selection. Press ◀▶ to select.



## Transponder menu

Press GREEN button to enter Transponder edit menu.

**Frequency:** Set the downlink frequency.

**Symbol (ks/s) :** Set the Symbol Rate.

**Polarity:** Set the polarity (horizontal or vertical).

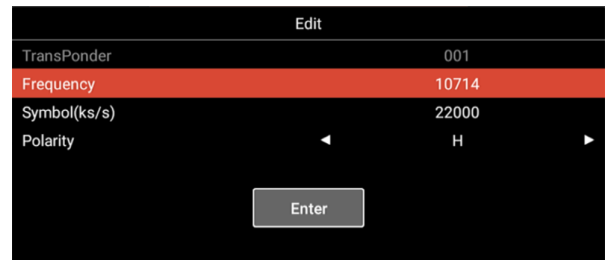

Press RED button to delete Transponder edit menu.

Press YELLOW button to enter the add Transponder menu.

**Frequency:** Set the downlink frequency.

**Symbol (ks/s) :** Set the Symbol Rate.

**Polarity:** Set the polarity (horizontal or vertical).

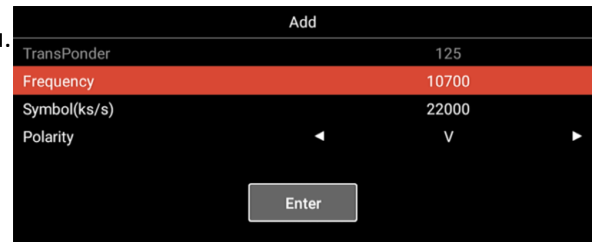

## Dish Parameter description

**LNB Type:** Highlight the LNB Type, and use the ◀▶ buttons or OK to enter submenu then you can set specific parameters.

**LNB Power:** Polarization switching power supply, Press ◀▶ to select On/Off.

**22KHz:** The level of the LO switch/ OS switch I Require the user to have installed 22KHzSatellite signal switch). Press ◀▶ to select Auto/On/Off.

**Tone burst:** Double Single Switch [Require users to install Tone burst switch), Press ◀▶ to select Burst A/Burst B/None.

**DiSEqC 1.0:** 4 select 1 switch I Require the user device support DiSEqC1 .0 protocol). Press ◀▶ to select LNB1/ LNB2/ LNB3/LNB4/None.

**DiSEqC 1.1:** 16 select 1 switch I Require the user device support DiSEqC1 .0 protocol) Equipment needs support DiSEqC 1.1 protocol, Most control 16tLNB. Press ◀▶ to select LNB1-LBN16/None.



## Scan menu

---

When all the parameters are set. Press BLUE button to enter the Channel Tuning menu.

**Scan Mode** : Select the scan mode to tune. (Default/blind Scan/Network).

**Channel Type**: Select FTA(Free to Air) or FTA (Free to Air) or ALL (Free to Air and Pay Channels).

**Service Type**: Select DTV(DVB TV) or Radio DTV (DVB TV) or Radio (DVB Radio) or both DTV & Radio.

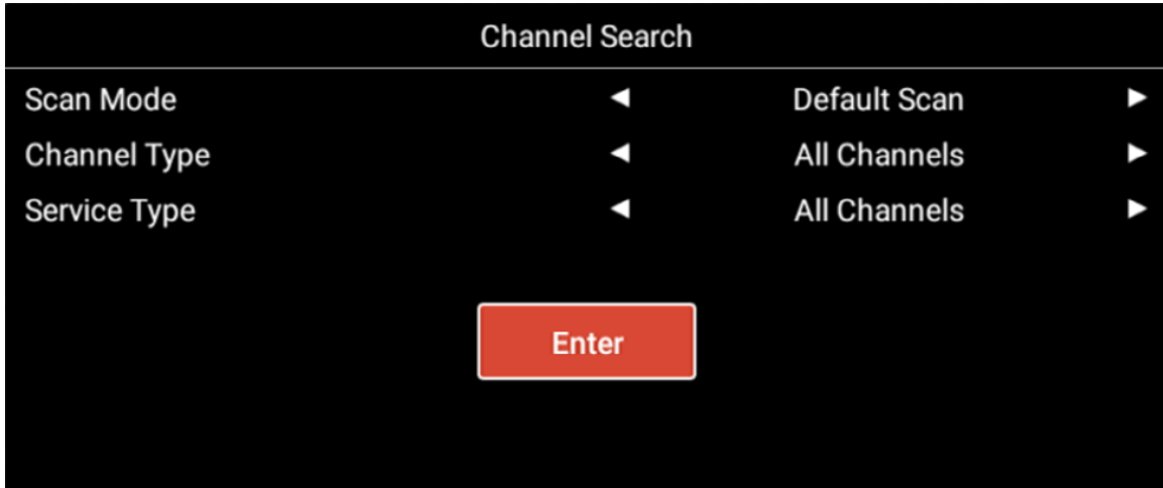

## Smart Features (Launcher screen)

### Launcher screen

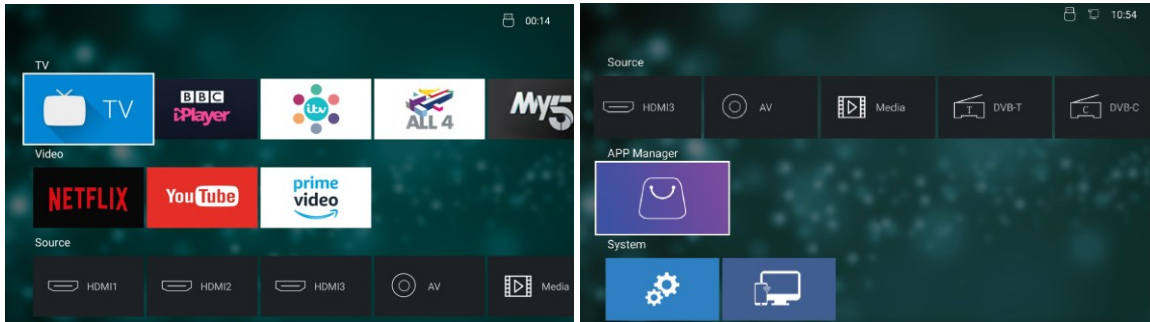

Top

Bottom

The TV on demand apps and streaming apps are listed in the top two rows.

**TV apps:** BBCiplayer/ITVHub/All4/My5/UKTVPlay

**Streaming apps:** Netflix/YouTube/Amazon prime Video

The apps are not pre- installed and you will need to install them by simply highlighting the app you want to install and pressing the OK key on the remote control. Press the OK key again to activate the download, the app will then download and install automatically.

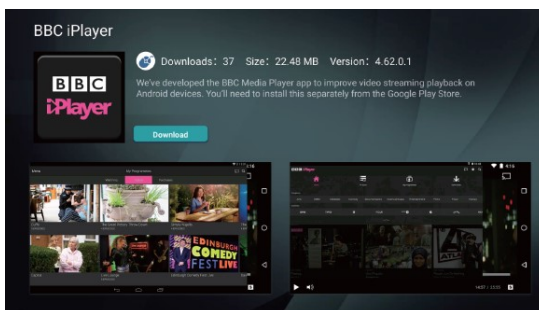

### App manager

The app manager is on the 4<sup>th</sup> row down and shows you what apps are installed and if any app updates are available.

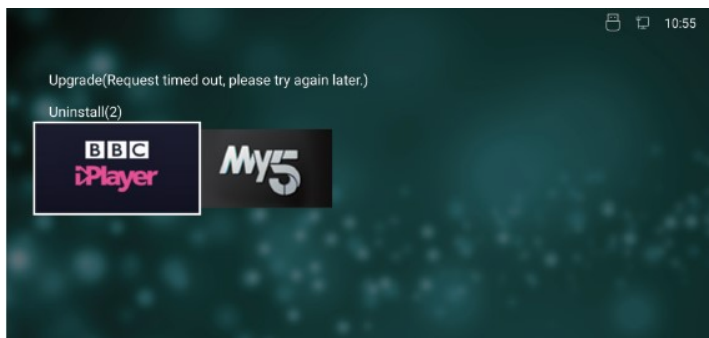

In this folder is also the option to uninstall any app. Uninstall by highlighting the app and press the OK key on the remote control. Select OK to uninstall.

If any updates are available, they will be in the app manager. If you find that an app is not opening on the home screen, please check the app manager for any updates.

To activate **Netflix** or **Prime video** you will need to have a Netflix and or an Amazon account with login details (user name and password)



**YouTube** will function normally but it is not possible to sign into a google account

### TV App

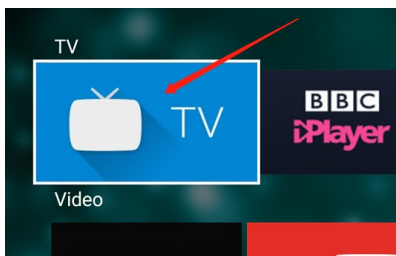

The TV link is a direct link to your television channels.

### Screen Mirroring

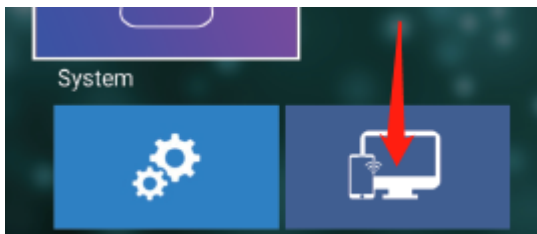

Highlight the Screen mirroring app then press the OK key on the remote control to activate. Now you can cast phones/Laptop/Tablets to the big screen

**Note:** The device and the TV must be connected to the same WIFI source

### System settings

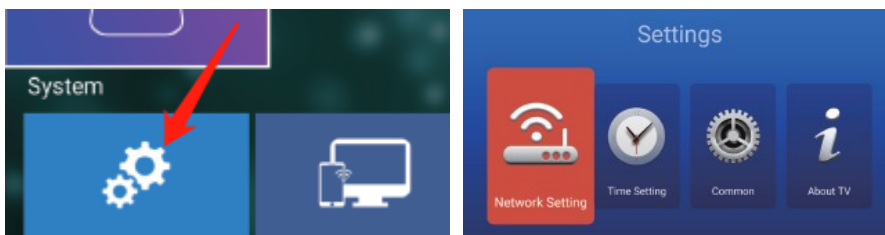

Highlight and press OK on the remote control to activate system settings

## Network Settings

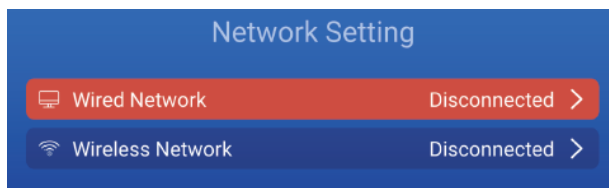

Highlight and select with the OK key on the remote control to open the wired and WIFI network settings.

## Time Settings

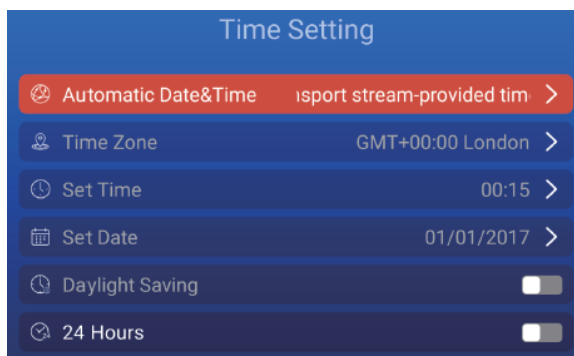

Highlight and select with the OK key on the remote control each option to set your preferences.

## Common settings

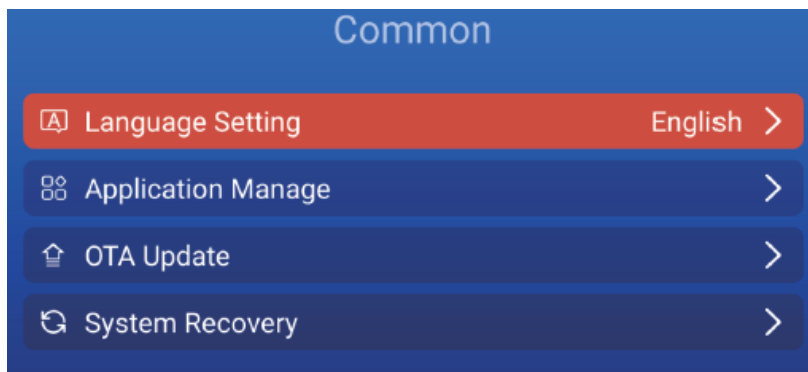

Highlight and select with the OK key on the remote control each option to set preferences.

**OTA Update:** If any updates are available for your TV you will receive an upgrade prompt when you start up your TV. If you want to check manually then select OTA Update.

**Note:** The update will not delete any apps or personal settings.

**System Recovery:** To do a factory data reset select System Recovery, this will put the TV software back to factory default settings.

**Note:** Be aware that this process will delete all personal settings and all apps will need to be reinstalled.



## DVD Operation

### Basic Operation

Press the Power button on the TV or the remote control, and select "DVD" source by the TV/AV(SOURCE). If there is no disc in the DVD player the screen will show "NO DISC". Insert Disc according to picture next to disc slot. Do not touch the playing surface. Hold the disc around the outside with your fingers and place the disc into the slot. The player will automatically draw the disc into the player. To "Eject" the disc, press the EJECT button on the TV or the "▲" button on the remote control.

### DVD Setup MENU

- DVD Setup is a menu to enable the user to configure the DVD settings.

#### Enter the DVD Setup menu

Press the DVD button on the remote control. When in the DVD setup menu use the ◀▶ button to navigate along the top of the menu and the ▲▼ to scroll up and down the menus.



#### Exit the DVD Setup menu

In the General setup page options scroll down to Exit setup and press OK.

## General Setup

### TV Display

#### 4:3 Pan Scan

This is selected when the DVD player is connected to a normal TV. Wide-screen images are shown on the screen, but with some parts cut automatically.

#### 4:3 Letter Box

This is selected when the player is connected to a normal TV. Wide-screen images are shown on the screen, with black bars on the top and bottom.

#### Wide

This is selected when the player is connected to a wide-screen TV.



#### OSD Language

This is used to select the OSD language



#### Screen Saver

Start the screen saver, the screen saver image will appear when the player stops or the picture is paused for a few minutes. This saver can keep the screen from being damaged.

- On (Start the screen saver)
- Off (Turn off the screen saver)



#### Last Memory

This setting enables you to watch the DVD from the last point it was turned off, (for example changing the source to watch TV)

- ON (Activate the last memory function)
- OFF (Deactivate the last memory function)



## AUDIO Setup

### • Speaker Setup

Enter the Audio setup page using ▼ button, press ok see the options.



### Downmix

#### • LT/RT

A disc recorded multi channel soundtrack, the output signal will be incorporated to left and right channel.

#### • Stereo

A disc recorded multi channel soundtrack, The output signal will be incorporated to stereo.



## Dolby Digital Setup

### Dynamic

This option is used to set the compression ratio in order to control the sound (Volume) contrast.



## Preference Setup



This menu is only available when in DVD mode and no DVD is playing or the DVD has been stopped.

### TV Type

#### PAL

This is selected when the player is connected to a PAL system TV.

#### MULTI

The player will set the TV system according to the disc in the tray.

#### NTSC

This is selected when the player is connected to a NTSC system TV.

### Audio

Choose the language you want to watch your DVD in. Only if the language is recorded to the DVD will this option be functional.

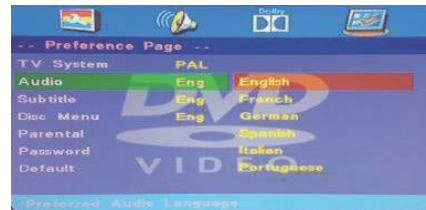

### Subtitle

Choose the subtitle language you want to watch. Only if subtitles have been recorded to the DVD will this option be functional.

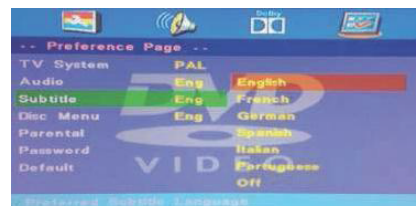

### Disc Menu

Choose the language you want to see the Disc menu in. Only if the language is recorded to the DVD will this option be functional.



## Parental

Parental lock gives you the option of selecting an age control grade. For example if PG is selected any disc inserted rated higher will not be played.

- KID SAFE
- G
- PG
- PG 13
- PGR
- R
- NC 17
- ADULT

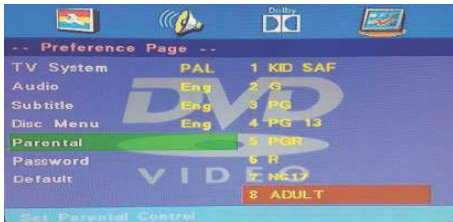

## Password

The password is a tool to lock and unlock the parental Lock setting.

Note: (Default password is 123456)



## Default

To set the DVD settings back to factory default, choose reset and press the OK button.

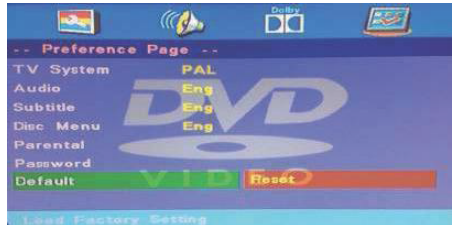

## Disc Care

### About Disc Terms

#### Title

Generally, pictures or music compressed on a DVD are divided into several sections, "title".

#### Chapter

The smaller section of picture or music in a DVD under the title, usually one title is comprised of one or more chapters and each of them is numbered for easy searching, but some discs may not have a recording chapter.

#### Track

A segment of picture or music on a CD, Each track is numbered for searching.

#### Care of Disc

Video disc contains high-density compressed data that needs proper handling.

1. Hold the disc with fingers by outer edge and/or the center spindle hole. Do not touch the disc surface.
2. Do not bend or press the disc.



3. Do not expose the disc to direct sunlight or heating sources, Store discs in cabinet vertically and in dry condition.

Prevent exposure to:

Direct sunlight

Heat or exhaust from a heating device

Extreme humidity

Clean the disc surface with a soft, dry cleaning cloth, Wipe the disc surface gently and radially from center toward the outer edge.

Do not apply thinner, alcohol, chemical solvent, or sprays when cleaning. Such cleaning fluids will permanently damage the disc surface.

## **Maintenance**

Be sure to disconnect the mains plug before cleaning the TV.

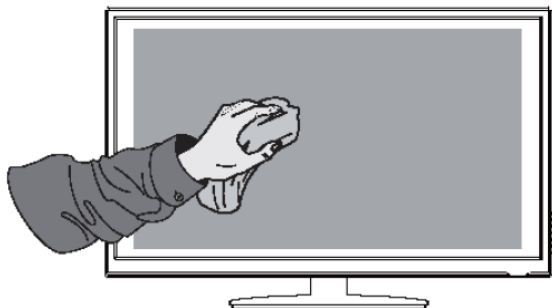

1. Use a soft dry cloth to wipe away the dust from the screen and plastic surfaces
2. Use warm soapy water to get rid of stubborn marks. Soak the cloth then wring it until almost dry before wiping the TV.
3. After cleaning allow any dampness on the screen to dry before switching on the TV

Important Note:

1. Never use alcohol, benzene, paint-thinner, cleaning fluid or other chemicals
2. Do not use compressed air to remove dust

## **Trouble shooting**

### **Warning**

Under no circumstances should you try to repair the TV by yourself, as this will invalidate the warranty. Do not remove the rear cabinet of the TV as there is a risk of electric shock. If a fault occurs, first check with the points listed below before calling the service help line ( 03334330312 ) for assistance.

<b>Problem</b>	<b>Solution</b>
No power	-Check if the power cable is connected correctly -Press the power key on the TV to turn on the power
TV does not respond to the remote control	-Aim the remote directly at the sensor on the TV -Reduce the distance to the TV -Aim the remote at the TV sensor and remove and replace the batteries.
TV freezes	-The processor may have crashed, turn the TV off at the mains and re-start the TV. If freezing persists, call the help line.
TV turns itself off	-Check that the sleep timer is not set to turn off -Check that the screensaver option "Put device to sleep" is set to Never. Default setting is 3hrs

## **Technical Specifications**

Screen size and system	19" LED
Max Screen resolution	1366 (H) x 768 (V)
Screen Brightness	200 Nits
Contrast Ratio	3000: 1
Power Source	AC 100-240V/DC 12V== 3A
Processor	A53 quad core CPU @900MHz
RAM	1GB DDR4
GPU	5 core ARM Mali-470
Built in Flash memory	8GB
Operating System	Android 7.1
Energy Efficiency Class	F
Average Annual Energy Consumption	17kWh
Speaker power	3W + 3W
Vesa wall mounting size / Screw size	100 x 100mm / M4 x 8
Dimension (W x D x H) without stand feet	440 x 44 x 275 mm
Dimension (W x D x H) with stand feet	440 x 160 x 307 mm
Net Weight	2.35Kg

## **Safety Warnings**

- Read all the instructions carefully before using the TV and keep them for future reference
- If you pass the TV onto a third party make sure to include this instruction manual
- Make sure that the voltage marked on the black rating label on the rear of the TV matches your mains voltage

### **Safety**

- Always disconnect the unit from the mains supply before connecting / disconnecting other devices or moving the TV
- Unplug the TV from the mains socket during a lightning storm

### **Mains Cable**

- If the mains cable is damaged it must be replaced by the manufacture, its service centre, or similarly qualified persons in order to avoid a hazard

### **Damage**

- Inspect the TV for damage after unpacking

- Do not continue to operate the TV if you are in any doubt about it working normally, or if it is damaged in any way – switch off, disconnect from the mains supply and call the service help line

### **Interference**

- Do not place the TV on or near appliances which may cause electromagnetic interference. If you do it may adversely affect the operating performance of the TV and cause distorted picture or sound

### **Optimum Viewing**

- View the TV in moderate light to prevent eye strain. It is recommended to watch the TV from a distance 3 – 7 times the screen height

### **LED Screen**

- The LED /QLED screens are manufactured using high precision technology. However, some tiny black dots/ or bright dots (red, blue, or green in colour) may constantly appear on the screen. These points are generated in the LED Screen manufacturing process.

### **Location**

- The TV must be placed on a flat stable surface and should not be subjected to vibrations
- The mains socket should be located close to the TV and should be easily accessible
- This TV is designed for indoor use only

### **Temperature**

- Avoid extreme degrees of temperature, either hot or cold. Place the unit well away from heat sources such as radiators or gas / electric fires
- Avoid exposure to direct sunlight and other sources of heat

### **Naked Flames**

- Never place any type of candle or naked flame on the top of or near the unit

### **Moisture**

- To reduce the risk of fire, electric shock or product damage, do not expose to the TV to rain, moisture dripping or splashing. Keep containers such as cups or vases filled with liquids away from the TV.

### **Ventilation**

- To prevent the risk of electric shock or fire hazard due to overheating, ensure that curtains and other materials do not obstruct the ventilation vents.
- Do not install or place this TV in a confined space. Ensure the TV is well ventilated
- Make sure that there is a gap of at least 10cm on both sides and a gap of 20cm at the top

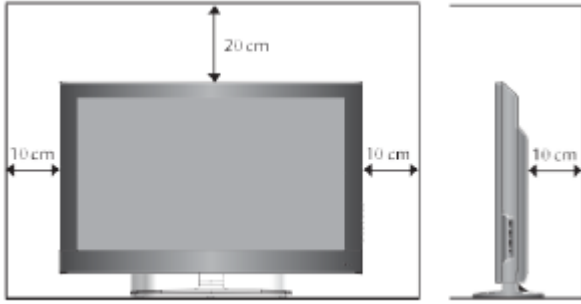

### Headphones

- Listening to loud sounds for prolonged periods of time may permanently damage your hearing

### Batteries

- Please keep the batteries for the remote control away from young children
- Please dispose of the batteries correctly by following the guidance in this manual

### Electronic waste recycling



■ This sign indicates that this product may not be disposed of with your regular household waste. The recycling and separate collection of such products is your responsibility. Please drop off the above-mentioned waste at a designated place for recycling electronic waste. If you do not know where to drop off, your electronic waste for recycling please contact your local council office or household waste collection service.



**Hg Cd Pb** The crossed out wheeled bin symbol indicates that batteries and / or accumulators must be collected and disposed of separately from household waste.

If the battery of accumulator contains more than the specified values of Lead (Pb), mercury (Hg), and/or cadmium (Cd) defined in the Battery directive (2006/66/EC), then the chemicals symbols for Lead (Pb), mercury (Hg), Cadmium (Cd) will appear below the crossed out wheeled dust bin symbol



**Pb** By participating in separate collection of batteries, you will help to assure the proper disposal of products and batteries thus help to prevent potential negative consequences for the environment and human health.

For more detailed information about the collection and recycling programmes available in your country, please contact your local city or council office.



This appliance complies with the European Safety and Electrical directives.

It fulfils the following EU regulations:

**EMC Directive 2014/30/EU**

**Test Standards:**

**EN55032:2015**

**EN55035:2017**

**EN61000-3-2:2014**

**EN61000-3-3:2013**

**LVD Directive 2014/35/EU**

**Test Standards:**

**EN 60065:2014**