

32" FVP LED TV

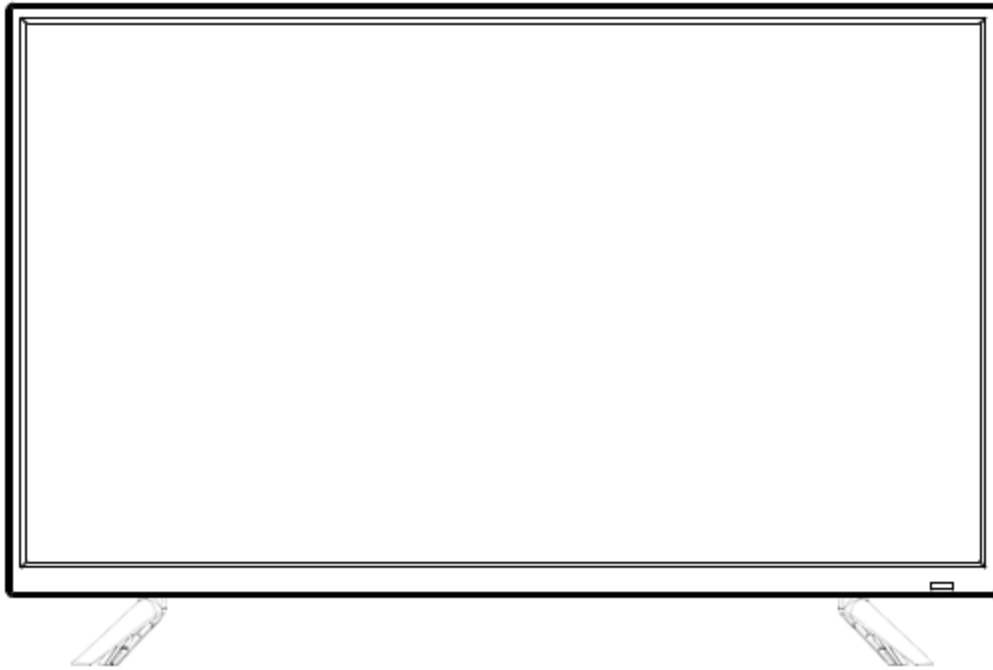

USER Manual

Contents

Unpacking the TV / Accessories	1
Installing / Removing the stand feet	2
Front / Right / Side view and controls	3
Rear View and Sockets	3
Remote Control	4-5
Video and Audio connections	6
Connecting the HDMI cable	6
Connecting the composite cable	7
Connecting a digital Audio receiver	8
Connecting Headphones	8
First time installation	9-11
Reset to Factory default	12
Quick remote control view	13
OSD Menus	14 -15
EPG	16
Netgem TV / App	17
Alexa voice setup and commands	18-20
Maintenance	21
Specifications / Safety warnings	22

Dear Cello customer

Thank you for purchasing your new 32" Freeview Play HD Television. This TV has many features and incorporates the latest technology to enhance your viewing experience. We recommend that you spend some time reading this instruction manual in order to fully understand these features. Hints and tips to resolve diverse issues are also available in the manual. Read all the safety instructions carefully before use and keep this instruction manual for future reference.

Unpacking / TV accessories



Television



Power cable



4 x Screws (ST4 x12)



Remote

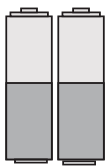

Batteries

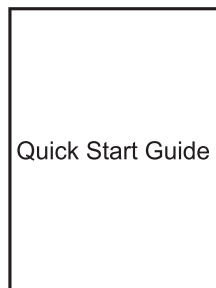

Quick Start Guide

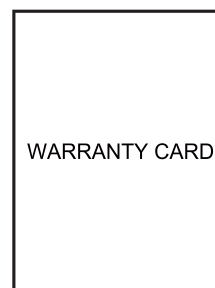

Warranty Card

Installing / Removing the stand feet

Parts



Television



4 x screws



Stand feet

Stand assembly instructions

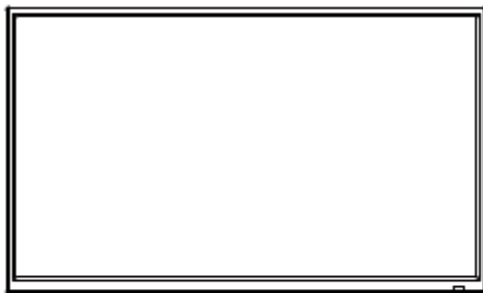

1. Attach the stand feet in the positions shown above
2. Fix the stand feet with the provide screws (4 x (ST4 x 12))

The Television is VESA-Compliant and designed to be wall mounted with a VESA-Compliant 200 x 100mm mounting kit. Mount the Television according to the instructions of the wall bracket (Not supplied)

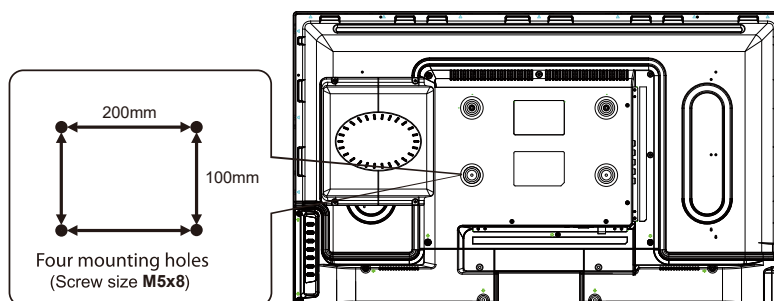

Front / Side view TV button controls

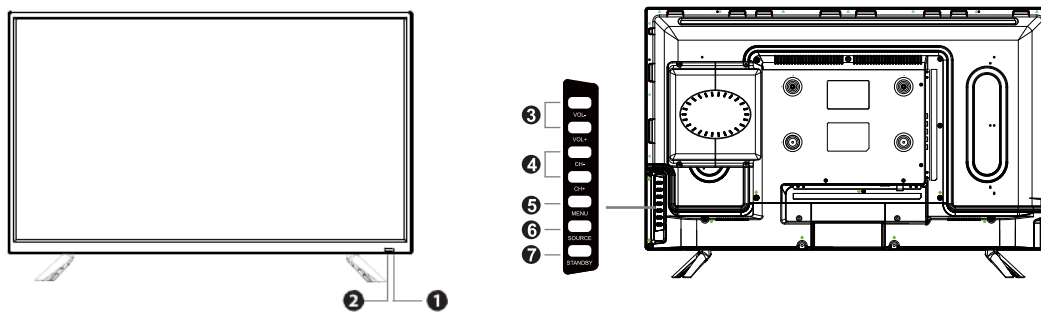

ITEM	DESCRIPTION
1 POWER LED	Illuminates Green when the TV is turned on. Illuminates Red when the TV is in Standby.
2 IR (Infrared Receiver)	Receives IR Signals from the remote control. Do not block the sensor.
3 VOL+/-	Adjusts the Volume
4 CH+/-	Selects channels
5 MENU	Displays the on screen display
6 SOURCE	Select from NETGEM/HDMI1/HDMI2/AV/USB
7 STANDBY	Turns the Television ON and OFF

Rear view sockets

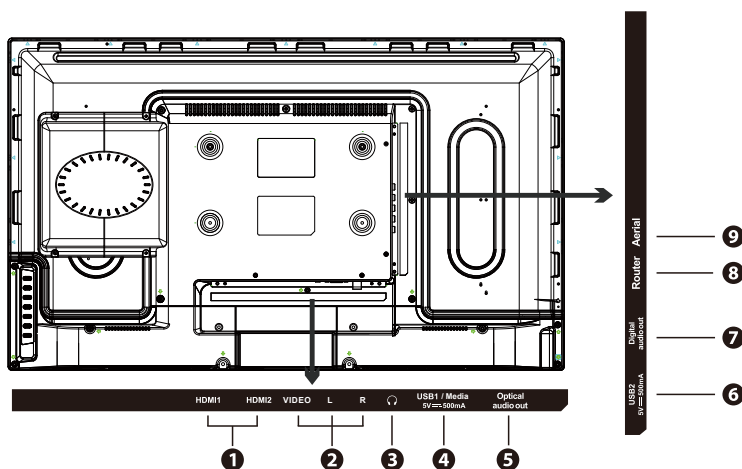

SOCKET	DESCRIPTION
1 HDMI INPUTS	Connect to external devices via HDMI cable
2 AV	Connect to external devices via AV cables
3 HEADPHONE	Connect to Headphones
4 USB	Connect to a USB storage device and play media files
5 OPTICAL AUDIO OUTPUT	Digital audio output to sound system
6 USB	For service and maintenance use only
7 COAX AUDIO OUTPUT	Digital audio output to sound system
8 RJ45 (ETHERNET)	Connect to the internet
9 TV Aerial	Connect to the domestic aerial socket

Installing Batteries in the Remote control

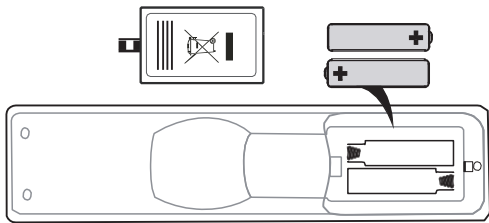

1. Insert 2 x 1.5V AAA batteries making sure to match the (+) and (-) ends of the batteries with the (+) and (-) ends shown in the batterie compartment.
2. Close the batterie compartment cover.

The Remote-Control Operation Range

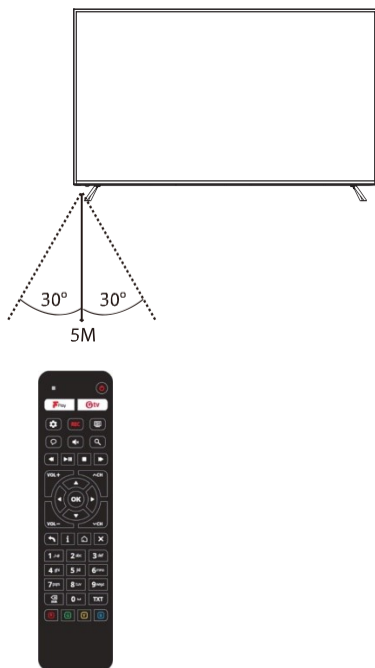

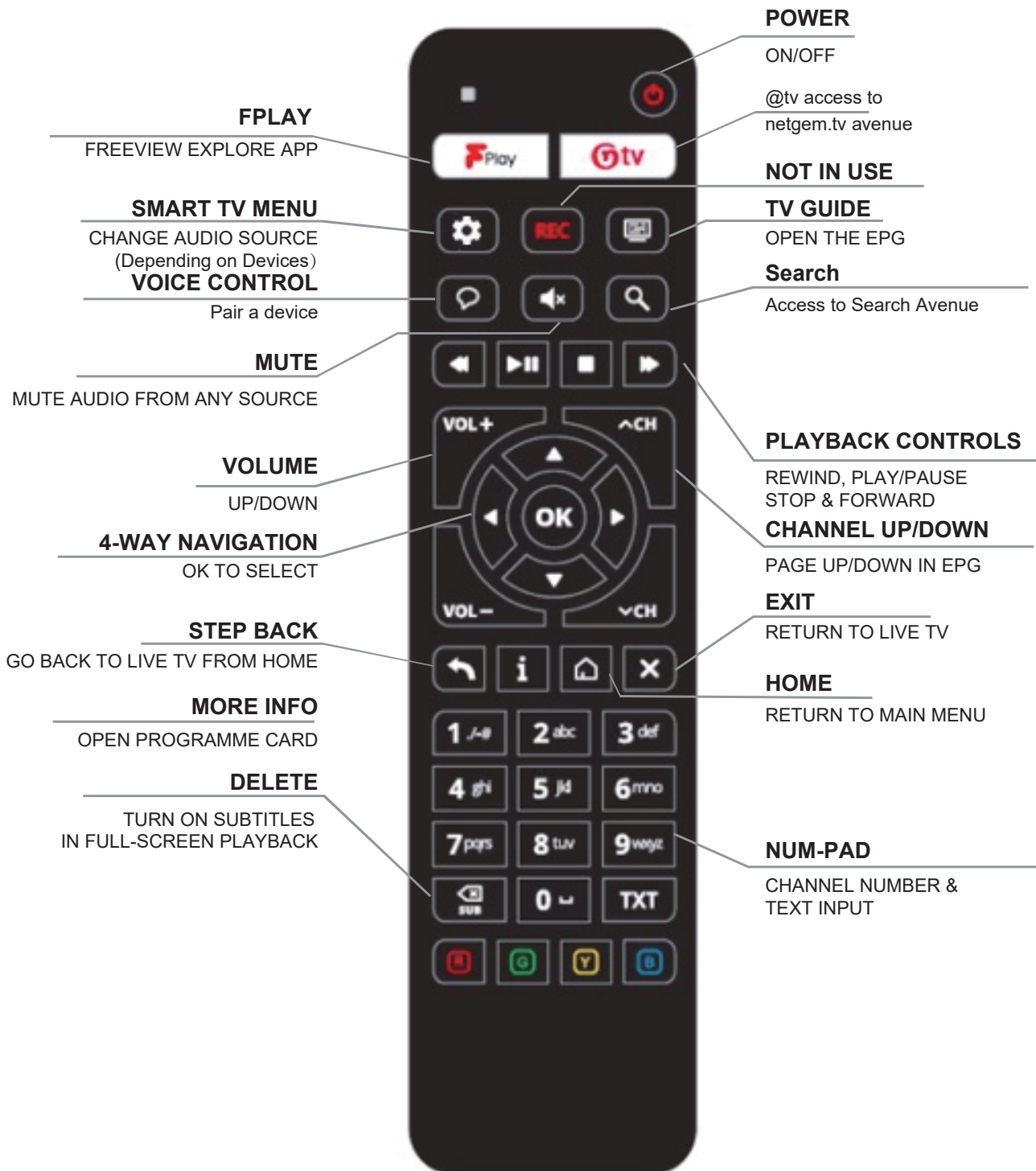

5 Meters is the normal distance recommended between the Remote control and the TV IR sensor and within 60° in front of the TV (See diagram). The operating distance may vary depending on the brightness of the room.

Remote control



Video and Audio connections

This TV supports High-Definition Multimedia Interface (HDMI) and High-Bandwidth Digital Content Protection (HDCP) Protocol.

Best Video Performance ↑		Signal Type	Separate Audio Connection Required
		 HDMI	HDMI (480i/480p/576i/576p/720p/1080i/1080p)
	 AV	Composite Video	No

Always connect a device to the TV with the highest quality connection available. Also, use good quality cables to ensure a good transfer of picture and sound.

An HDMI connection has the best picture and sound quality. One HDMI cable combines video and audio signals.

Connecting an AV device with HDMI cable

Audio/Video devices:

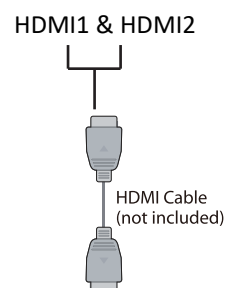
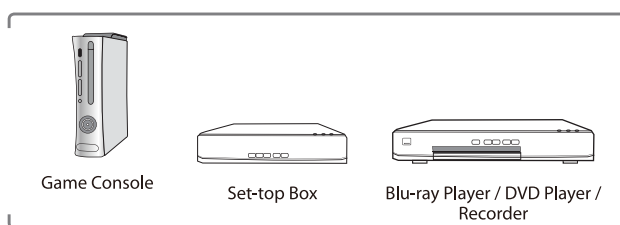

After connecting to an external device (Blu-ray disc player, Game console, Set-top box, or personal computer) with the HDMI cable. Select the HDMI in the source menu and the TV will automatically detect the resolution coming from the device. For the best picture quality adjust the device output resolution up to 1920 x 1080.

Connecting an AV device with a composite cable

Connect the Television to an AV device with the RED = Audio Right / YELLOW = Video / WHITE = Audio Left Cinch connector composite cable. Select the AV source on the Television to view content from the attached device.

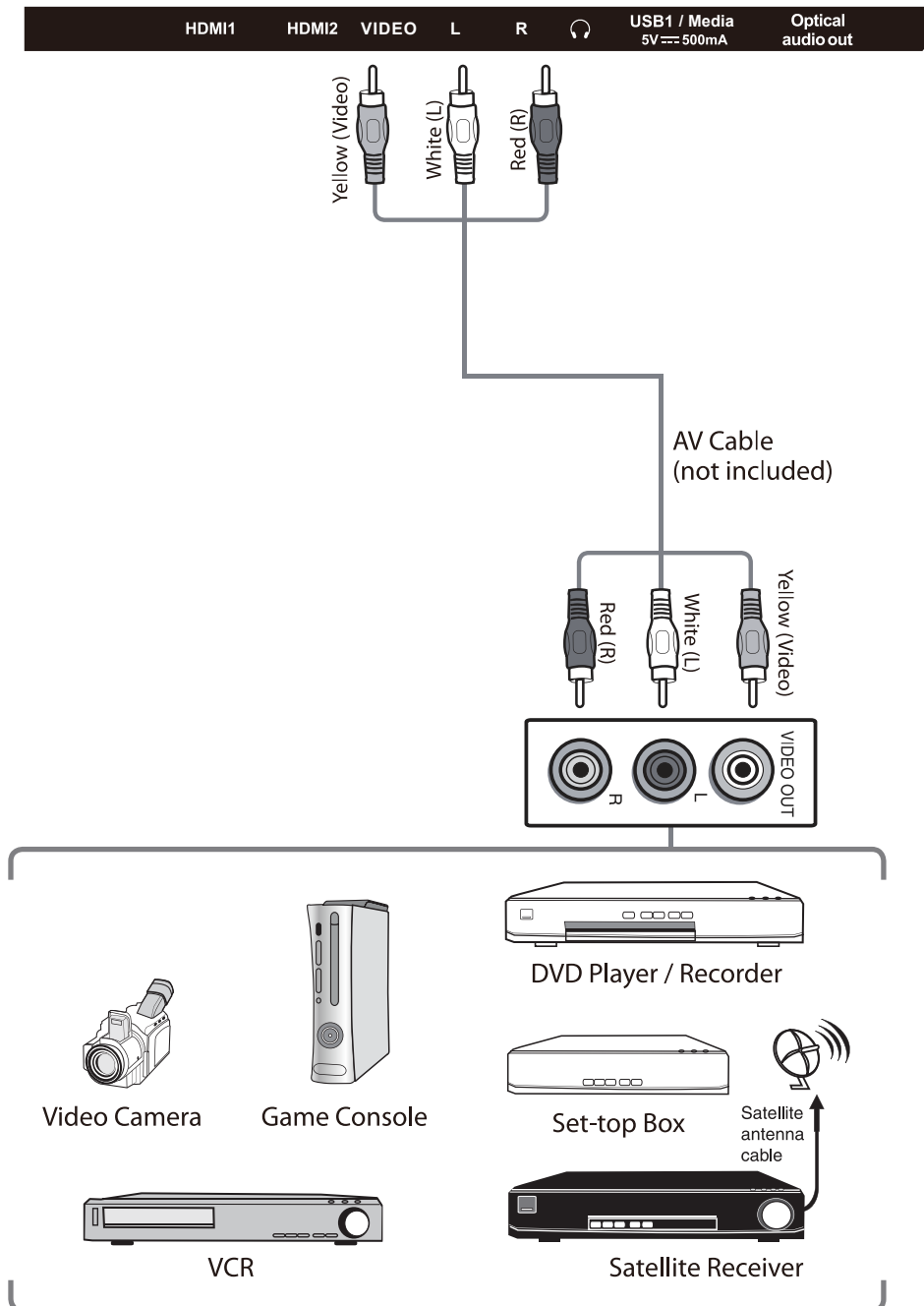

Connecting a digital audio receiver

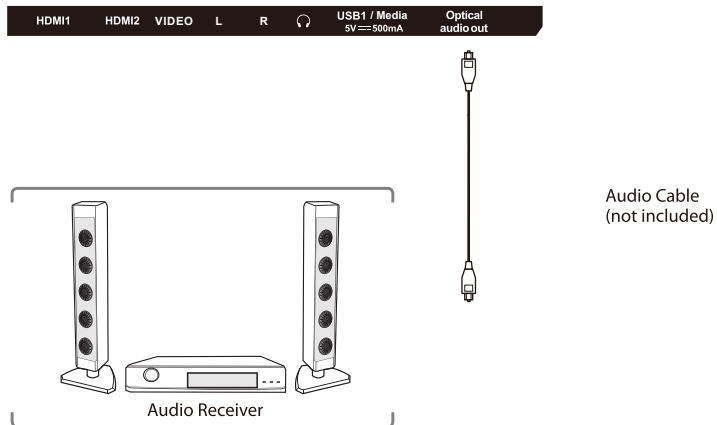

For a better sound quality, you may want to listen to the TV audio output through your Home Sound System or Sound bar. The TV is fitted with an Optical Digital Audio Output. When purchasing a cable, it must be an Optical cable. When the Optical cable is connected to both devices select the source mode optical on the Sound system or Sound bar.

Connecting Headphones

Connect the headphones to the TV's headphone socket. Before using the headphones make the volume is low and then increase to a comfortable listening level.

Long term exposure to loud music may cause hearing damage. It is best to avoid extreme volume when using earphones, especially for long lengths of time.

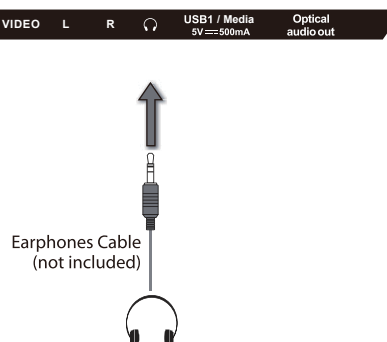

First Time Installation wizard

When the TV is started for the first time the First Time Installation process will start. Follow the below steps

1. **Connect to an aerial** Connect to an aerial coaxial cable (not provided) from your wall socket (linked to a rooftop aerial) to the aerial socket of your TV.
2. **Select START** (Select by pressing the OK key on the remote control)

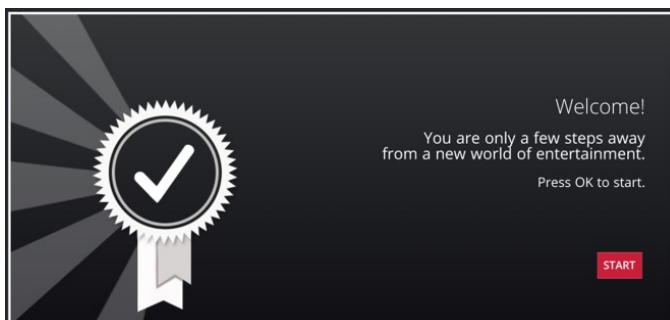

3. **Connect your smart TV to the Internet** Using your WiFi connection or an ethernet cable (not provided)
4. **Ethernet (Connects automatically when ethernet cable is inserted)**

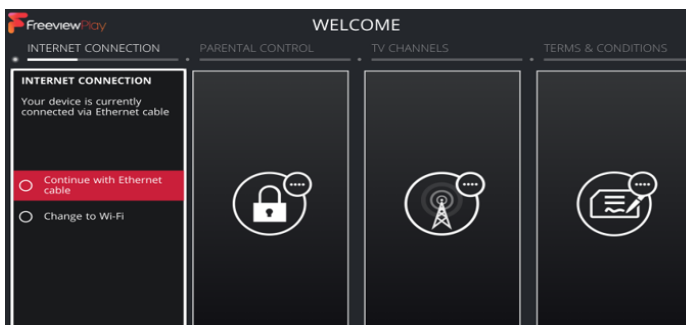

WIFI (Select your WIFI connection)

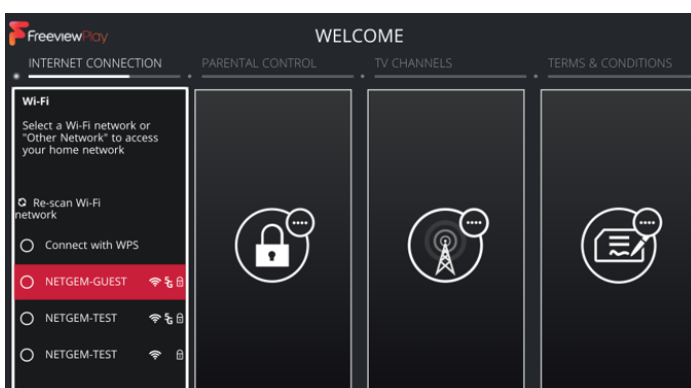

Type in the WIFI Password

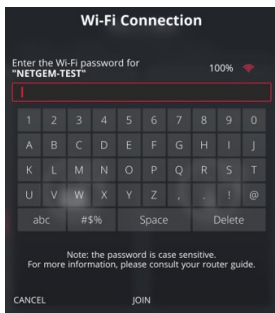

Select Join to connect

5. Choose your 4 digit pin code

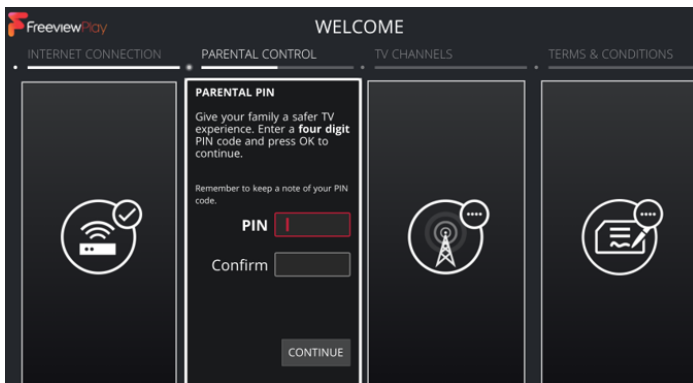

6. Setup parental control Choose a four-digit code, using your remote control

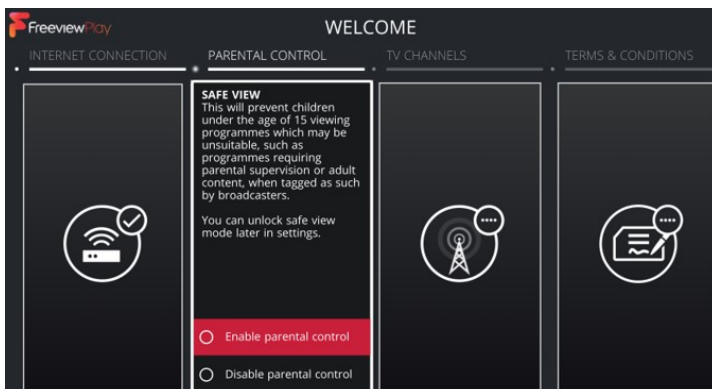

7. Scan Freeview channels (Requires step 1 – connect to an aerial)

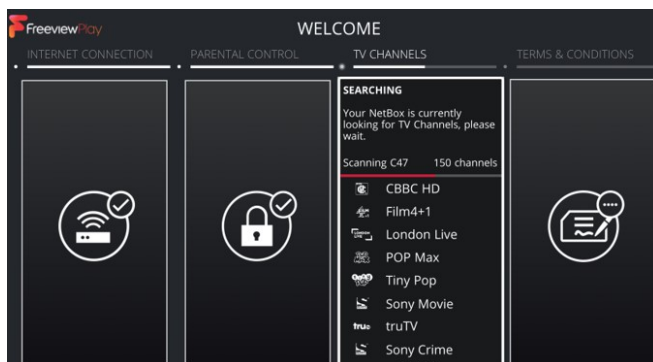

8. Accept the T & Cs Read and accept the netgem.tv term

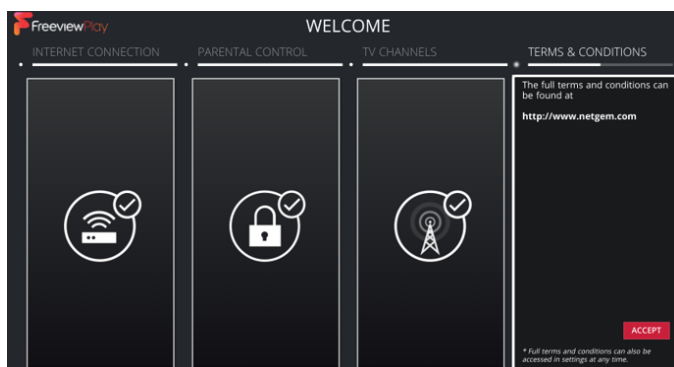

9. Get the mobile app to finish the setup of the smart TV service and enjoy personal TV recommendations, download, and pair your smart TV with the netgem.tv Mobile App. (This step can be skipped by pressing the OK key on the remote control when the word SKIP appears on the screen)



Reset the TV to factory default settings

If later, you wish to reset the TV to factory default settings. (**Please be aware that this option will delete all your preloaded settings**)

Press the home key on the remote control and select the cog wheels at the top of the page to access the settings options.

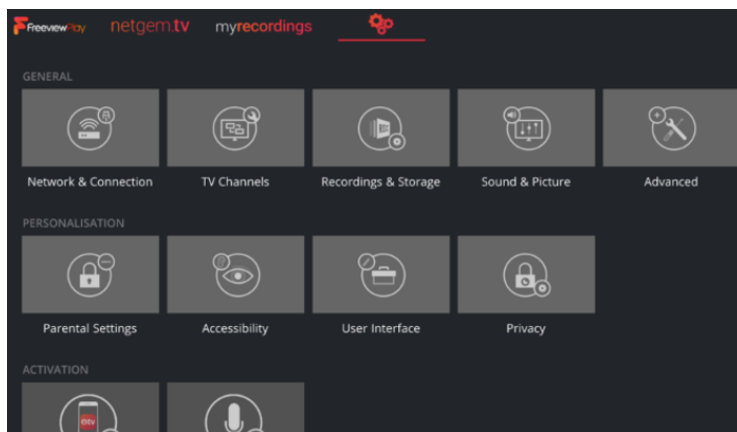

Follow steps below (**Select by highlighting the option and pressing the OK key on the remote control**)

1. Select **Advanced**
2. Enter the pin code and select **CONTINUE**
3. Scroll down and select **Reset settings**
4. Select **CONTINUE**
5. The TV will Reboot and reset
6. The First-Time installation will appear on the screen

Selecting the Input Source

1. Press the cog wheel key on the remote control once to display the source menu. Select the up/down navigation keys to select the source required. Choose from NETGEM/HDMI1/HDMI2/AV/USB
2. Press the OK key to confirm

Quick Remote-control view

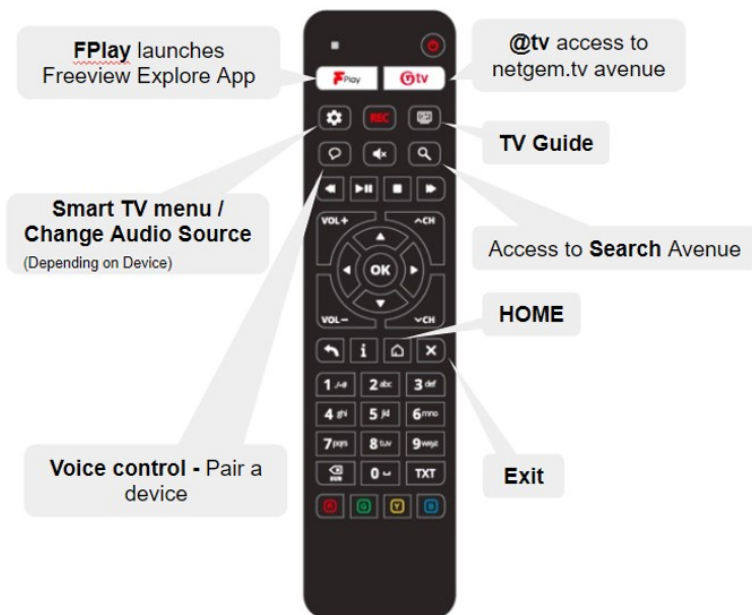

Channel selection options

1. Use the Ch+/- key on the remote control to go up and down the channels
2. Type in the channel numbers using the numeric keys on the remote control. The number being typed in will appear top left of your screen in red. The TV will tune to the chosen channel. This process can be accelerated by pressing the OK key on the remote control after the channel number is on the screen.
3. Press any of the navigation keys on the remote control to display the channel list. Using the up/down navigation keys on the remote control to scroll to the channel you require. Press the OK key on the remote control to activate.

Display Channel Information

1. Press the Info key on the remote control to display the channel information. Select the settings option in the info bar to turn ON/OFF the subtitles.
2. Select the more info option in the info bar to see more information on the current programme and to see other episodes that are available to watch.

Volume Adjustment

1. Press the Vol+/- key on the remote control to increase and decrease the volume on the TV.
2. Press the Mute key on the remote control to turn off the sound completely. Once the sound is muted. Press the mute key or the Vol+ key on the remote control to deactivate the mute function.

Picture options in TV mode (Television)

To navigate all menus, use the up/down/left/right navigation keys on the remote control. Press the Cog symbol (source/menu) key on the remote control to return to previous menu.

1. Press the Cog symbol (source/menu) key on the remote control twice to access the main user menu.
2. Picture options are the first options available in the menu. Press the OK key to enter the Picture menu options.
3. Picture Mode: Select from Standard/Dynamic/Mild/User
4. Colour Temperature: Select from Normal, Cool (Increases blue tint), Warm (Increases red tint)
5. Aspect Ratio: Select from 4:3/16:9/Zoom1/Zoom2/Just scan/Point to Point

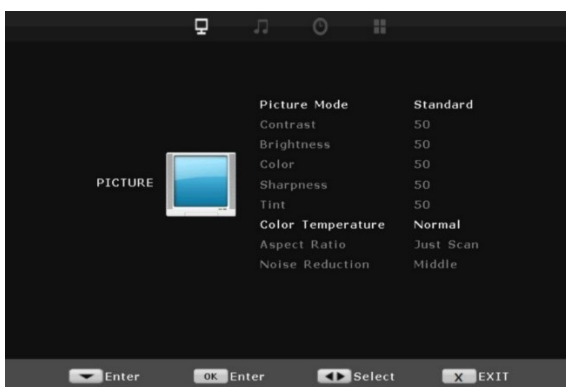

Sound options in TV mode (Television)

1. Press the Cog symbol (source/menu) key on the remote control twice to access the main user menu.
2. Press the right navigation key to access the Sound menu
3. Sound Mode: Select from Standard/Music/Movie/Sports/User
4. Balance: Using the left/right navigation key select your preference of audio balance
5. Auto Volume: This feature automatically adjusts the audio level when the TV is turned on
6. Surround sound ON/OFF
7. SPDIF select from AUTO/PCM (AUTO is the default setting)

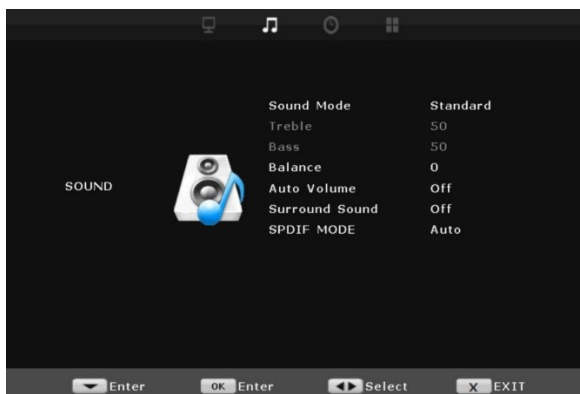

Time options in TV mode (Television)

1. Sleep Timer : Select between 10 -240 minutes
2. Auto Sleep: Select between 3Hrs/4Hrs and OFF



OPTION setting in TV mode (Television)

1. Language setting: Select your language
2. Home mode: Select between Home/Max economy/Max brightness
3. Backlight: Adjust the backlight setting
4. Software Update(USB): Used by technicians to upgrade the TV software during maintenance
5. Reset: This setting will revert the TV software back to factory settings. All settings will be set to factory defaults.

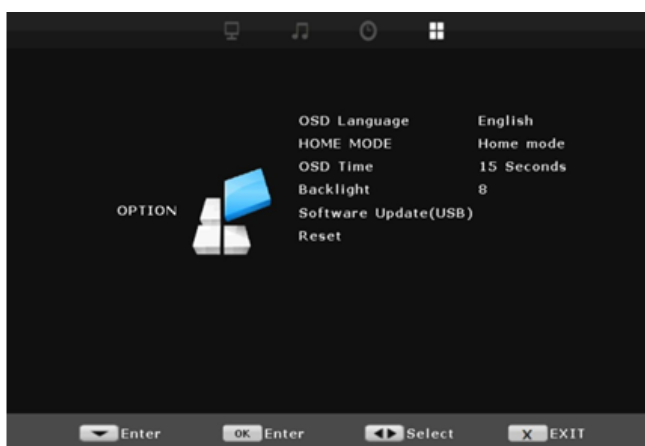

Freeview play EPG

Freeview Play, integrating Freeview HD TV, online catch-up TV and on-demand services into one single TV platform. You can get all the TV you want from the BBC, ITV, Channel 4 and Channel 5, plus a range of smaller broadcasters. What's more, you get BBCiPlayer, All 4, My5 and UKTVplay plus other catch-up services, all without paying a subscription.

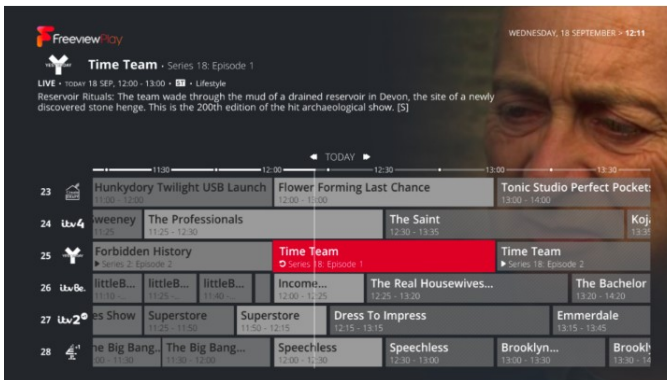

The EPG looks much like what you'd find on any modern Freeview HD TV, with a grid of channels and programmes on which you can check not only what's on today but what's coming up later in the week. However, where a normal EPG only scrolls forwards, the

The Freeview Play EPG can go backwards, too. You can scroll back or search to look for programmes that have already aired, and when you select one the EPG will open it automatically from within the appropriate catch-up TV app. It can be a faster, more convenient way to find something you missed than manually checking out different catch-up apps and trying to dig out the right episode. Freeview Play allows you to look back through up to the last seven days of broadcasts.

netgem.tv

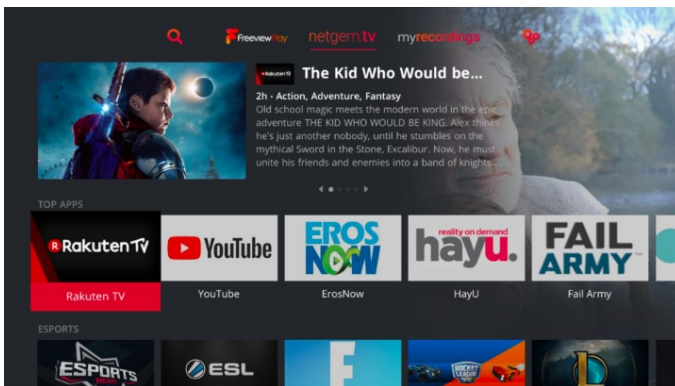

In addition to the UK free-to-air players from broadcasters the BBC, ITV, Channel 4, Channel 5 and UKTV, the service includes Amazon Prime Video, YouTube, Rakuten TV, Hayu, Hopster, Trace TV and others.

netgem.tv app

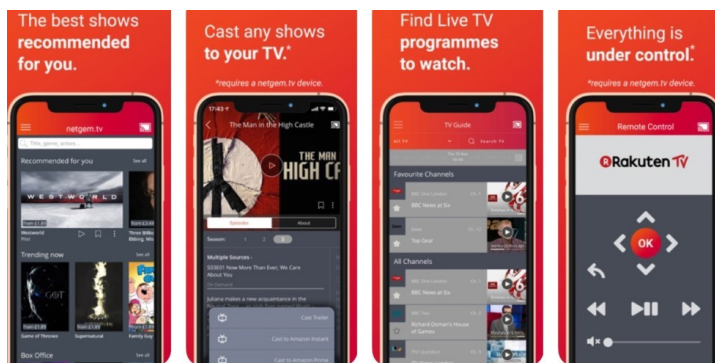

The netgem.tv mobile app is the perfect way to take full advantage of netgem.tv.

Download the netgem.tv app from Google playstore / apple store 
Register the TV with the netgem.tv app and enjoy the features below

1. Cast any selected video to your TV from apps such as Amazon Prime / Rakuten TV.
2. Use your mobile as Remote control
3. For more info on the netgem.tv app go to <https://www.netgem.co.uk/#>

Alexa Voice control

How to set up the TV voice control with Amazon Alexa

Notice:

You need to have a registered Amazon Alexa device installed to be able to use this feature.

Turn on your TV.

Press the voice activation key on the remote control to activate the Alexa voice control. The Voice activation key is situated third row down on the top left of the remote control.



Voice activation key

The activate Voice control menu will show on the screen. Follow these instructions on your smartphone/ tablet/ web browser to use the Amazon Alexa device to control the TV.

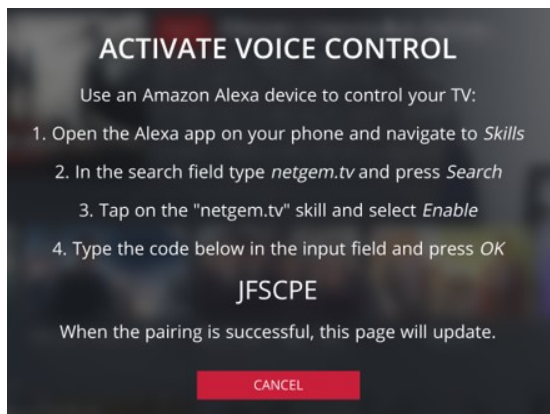

You will now be prompted to pair your Netgem TV skills app with your TV using the activation code shown on the TV screen.

Type in the activation code on your phone and press OK.

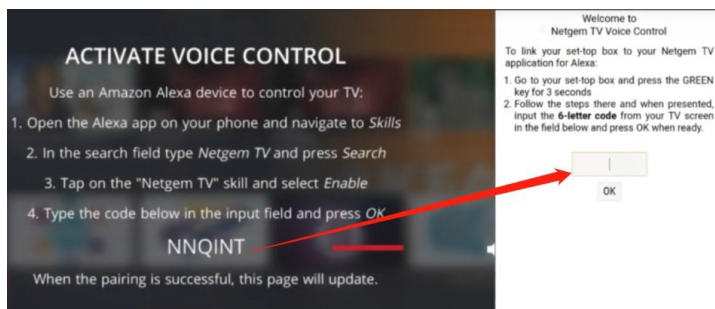

TV Screen

Smart Phone

A VOICE CONTROL ACTIVATED pop up will show on the screen. Press DONE to complete the Alexa voice control setup procedure.

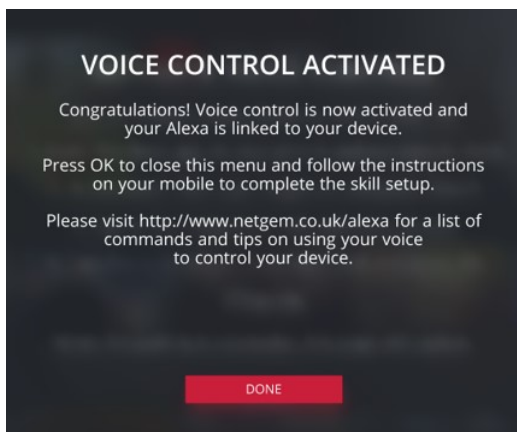

Your voice control is now activated, and you can start using Alexa with your TV.

Alexa voice commands for your TV

To go to a TV channel

Alexa, go to BBC One

Alexa, tune to Channel 103

Alexa, change to ITV

Search in Live TV content

Alexa, to Search EastEnders

Alexa, to find programme called Frasier

Alexa, to search for Peppa Pig

Watch Live TV Programme

Alexa, watch Homes Under the Hammer

Play a content from any app that is available in the Hubs

Alexa, play Grand Tour

Launch App

Alexa, to launch Amazon Prime Video

Alexa, go to Hopster

Alexa, to Start Radioline

Pause/ Play Alexa,

to Pause Alexa, to

Play Guide

Alexa, go to Guide

Changing volume

Alexa, to Mute/ Unmute

Alexa, **Other**

Set volume to 40

Alexa, go to home

Maintenance

Be sure to disconnect the mains plug before cleaning the TV.

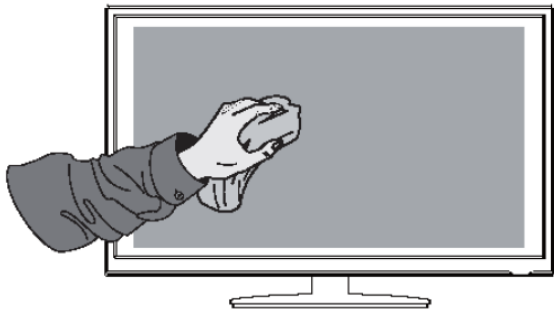

1. Use a soft dry cloth to wipe away the dust from the screen and plastic surfaces
2. Use warm soapy water to get rid of stubborn marks. Soak the cloth then wring it until almost dry before wiping the TV.
3. After cleaning allow any dampness on the screen to dry before switching on the TV

Important Note:

1. Never use alcohol, benzine, paint-thinner, cleaning fluid or other chemicals
2. Do not use compressed air to remove dust

Trouble shooting

Warning

Under no circumstances should you try to repair the TV by yourself, as this will invalidate the warranty. Do not remove the rear cabinet of the TV as there is a risk of electric shock. If a fault occurs, first check with the points listed below before calling the service help line (03334330312) for assistance.

Problem	Solution
No power	-Check if the power cable is connected correctly -Press the power key on the TV to turn on the power
TV does not respond to the remote control	-Aim the remote directly at the sensor on the TV -Reduce the distance to the TV -Aim the remote at the TV sensor and remove and replace the batteries.
TV freezes	-The processor may have crashed, turn the TV off at the mains and re-start the TV. If freezing persists, call the help line.
TV turns itself off	-Check that the sleep timer is not set to turn off -Check that the screensaver option "Put device to sleep" is set to Never. Default setting is 3hrs

Technical Specifications

Panel System	32 Inch LED Panel
Display Resolution	1366 pixels (horizontal) x 768 pixels (Vertical)
Television System	DVBT2 / FreeView Play
Brightness	200cd/m ²
Contrast Ratio	3000 : 1
Power Source	AC100 – 240V
Energy Efficiency Class	A
Operating Power Consumption	34W
Average Annual Energy Consumption	50kWh
Operating Temperature	0°C-50°C
Vesa Wall mounting size / Screw size	200 x 100mm / M5 x 8
Dimensions (W x D x H) without stand	731 x 87 x 437mm
Dimensions (W x D x H) with stand	731 x 180 x 487mm
Weight (Net)	5.2 kg

Safety Warnings

- Read all the instructions carefully before using the TV and keep them for future reference
- If you pass the TV onto a third party make sure to include this instruction manual
- Make sure that the voltage marked on the black rating label on the rear of the TV matches your mains voltage

Safety

- Always disconnect the unit from the mains supply before connecting / disconnecting other devices or moving the TV
- Unplug the TV from the mains socket during a lightning storm

Mains Cable

- If the mains cable is damaged it must be replaced by the manufacture, its service centre, or similarly qualified persons in order to avoid a hazard

Damage

- Inspect the TV for damage after unpacking

- Do not continue to operate the TV if you are in any doubt about it working normally, or if it is damaged in any way – switch off, disconnect from the mains supply and call the service help line

Interference

- Do not place the TV on or near appliances which may cause electromagnetic interference. If you do it may adversely affect the operating performance of the TV and cause distorted picture or sound

Optimum Viewing

- View the TV in moderate light to prevent eye strain. It is recommended to watch the TV from a distance 3 – 7 times the screen height

LED Screen

- The LED / QLED screens are manufactured using high precision technology. However, some tiny black dots/ or bright dots (red, blue, or green in colour) may constantly appear on the screen. These points are generated in the LED Screen manufacturing process.

Location

- The TV must be placed on a flat stable surface and should not be subjected to vibrations
- The mains socket should be located close to the TV and should be easily accessible
- This TV is designed for indoor use only

Temperature

- Avoid extreme degrees of temperature, either hot or cold. Place the unit well away from heat sources such as radiators or gas / electric fires
- Avoid exposure to direct sunlight and other sources of heat

Naked Flames

- Never place any type of candle or naked flame on the top of or near the unit

Moisture

- To reduce the risk of fire, electric shock or product damage, do not expose to the TV to rain, moisture dripping or splashing. Keep containers such as cups or vases filled with liquids

away from the TV.

Ventilation

- To prevent the risk of electric shock or fire hazard due to overheating, ensure that curtains and other materials do not obstruct the ventilation vents.
- Do not install or place this TV in a confined space. Ensure the TV is well ventilated
- Make sure that there is a gap of at least 10cm on both sides and a gap of 20cm at the top.

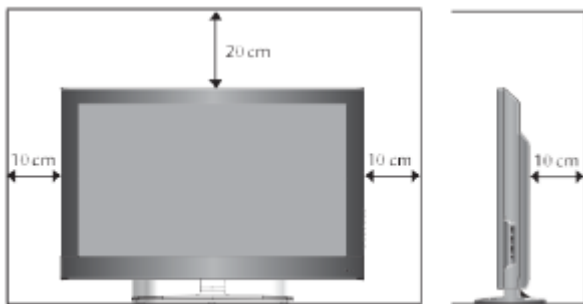

Headphones

- Listening to loud sounds for prolonged periods of time may permanently damage your hearing

Batteries

- Please keep the batteries for the remote control away from young children
- Please dispose of the batteries correctly by following the guidance in this manual

Electronic waste recycling



■ This sign indicates that this product may not be disposed of with your regular household waste. The recycling and separate collection of such products is your responsibility. Please drop off the above-mentioned waste at a designated place for recycling electronic waste. If you do not know where to drop off, your electronic waste for recycling please contact your local council office or household waste collection service.



Hg Cd Pb The crossed out wheeled bin symbol indicates that batteries and / or accumulators must be collected and disposed of separately from household waste.

If the battery or accumulator contains more than the specified values of Lead (Pb), mercury (Hg), and/or cadmium (Cd) defined in the Battery directive (2006/66/EC), then the chemicals symbols for Lead (Pb), mercury (Hg), Cadmium (Cd) will appear below the crossed out wheeled dust bin symbol



By participating in separate collection of batteries, you will help to assure the proper disposal of products and batteries thus help to prevent potential negative consequences for the environment and human health. For more detailed information about the collection and recycling programs available in your country, please contact your local city or council office.



This appliance complies with the European Safety and Electrical directives. It fulfils the following EU regulations:

