

40" Smart TV

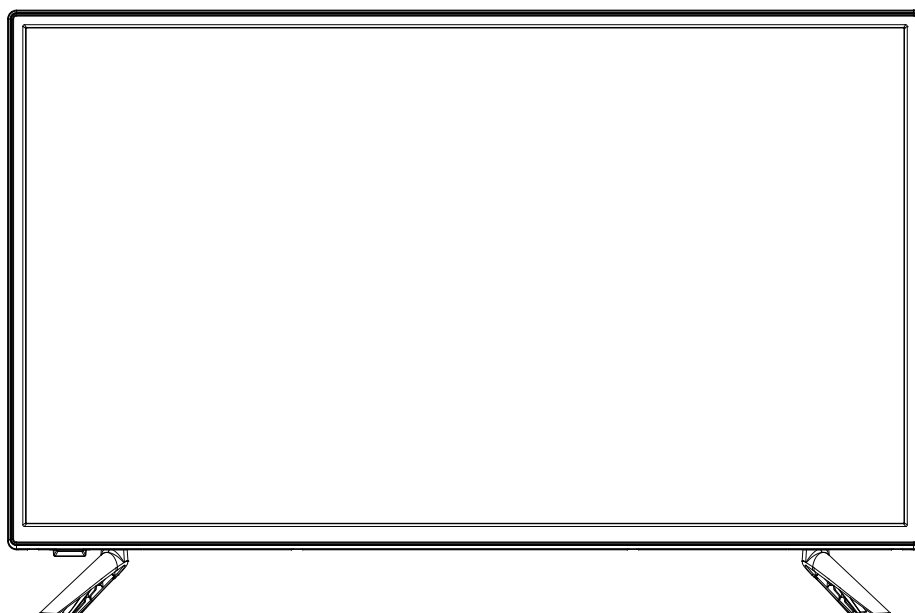

INSTRUCTION MANUAL

Contents:

Preface/ Whats in the box/ Fixing the stand feet	3
Wall mounting/ Front IR sensor and TV buttons	4
Rear view connections	5
Remote control	6-8
Video and Audio connections/ Connecting AV with HDMI	9
Connecting digital audio device/ Connecting a USB storage device	10-11
Power on the TV for the first time	11
First time installation wizard	12
Reset to factory default/ Select source/ Channel selection options	13-14
Picture options	14
Sound options/ Channel setup	15-17
Function menu	17-18
Setup menu	18
Smart features	19-21
Maintenance/ Trouble shooting	22
Technical Specifications	23
Safety warnings	23-26

Preface:

Thank you for choosing our 40" Smart TV. This TV has many features and incorporates the latest technology to enhance your viewing experience. We recommend that you spend some time reading this instruction manual in order that you fully understand these features. Read all of the safety instructions carefully before use and keep this instruction manual for future reference.

Whats in the box:

- TV
- Stand & Stand fixing Screws ((M4 x 17) x4)
- Power cable
- Remote control
- Batteries (2 x AAA)
- Quick start guide
- Warranty card

Fixing and the TV stand feet

Place the TV face down on a soft and flat surface (blanket, foam, cloth, etc.) to prevent any damage to the TV.

1. Attach the stand feet in the positions shown below and secure them with supplied screws ((M4 x 17) x 4)

Fixing the TV stand feet

Place the TV face down on a soft and flat surface (blanket, foam, cloth, etc.) to prevent any damage to the TV.

1. Attach the stand feet in the positions shown below and secure them with supplied screws ((M4 x 17) x 4)

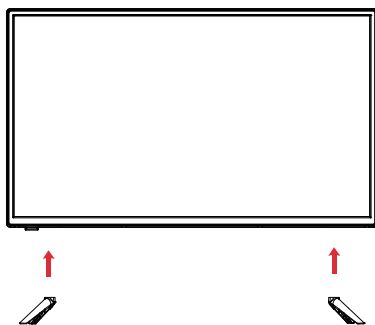

Wall mounting:

This TV is VESA-Compliant and has been designed to be wall mounted with a VESA-Compliant wall mounting kit. (Wall mounting kit and screws not included)

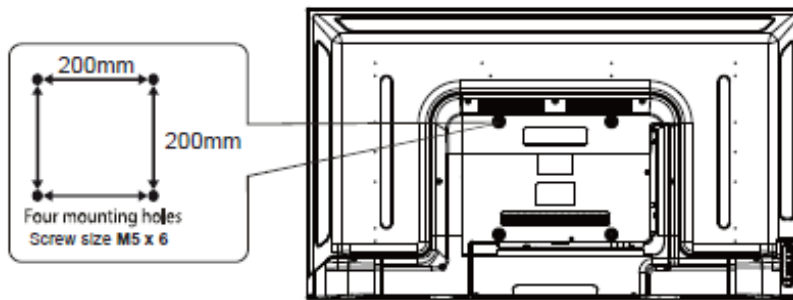

Front IR sensor and TV buttons

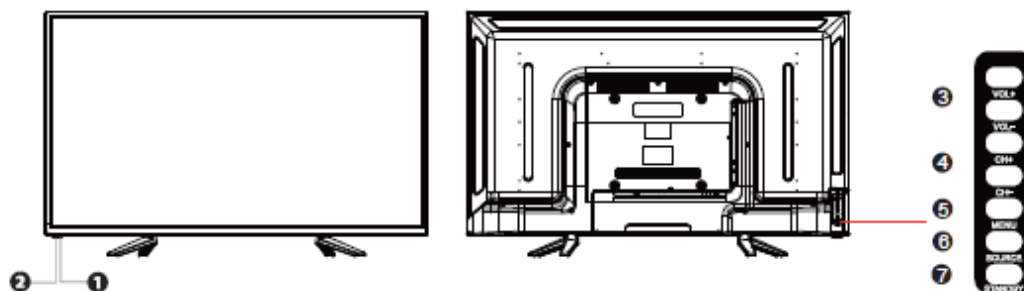

1	IR (Infrared Receiver)	Receives IR signals from the remote control. Do not put anything near the sensor, as its function may be affected.
2	Power LED	Illuminates green when the TV is turned on. Illuminates red when the TV is in standby mode. The LED will alternate between red and green when the REC timer programming has started in standby mode.
3	VOL +/-	Adjust the volume
4	CH +/-	Select channels
5	MENU	Displays the on-screen Menu options
6	SOURCE	Select input source (HDMI1, HDMI2, HDMI3, HDMI4, AV)
7	STANDBY	Switches the TV ON/OFF from and to Standby mode

Rear View and Connections

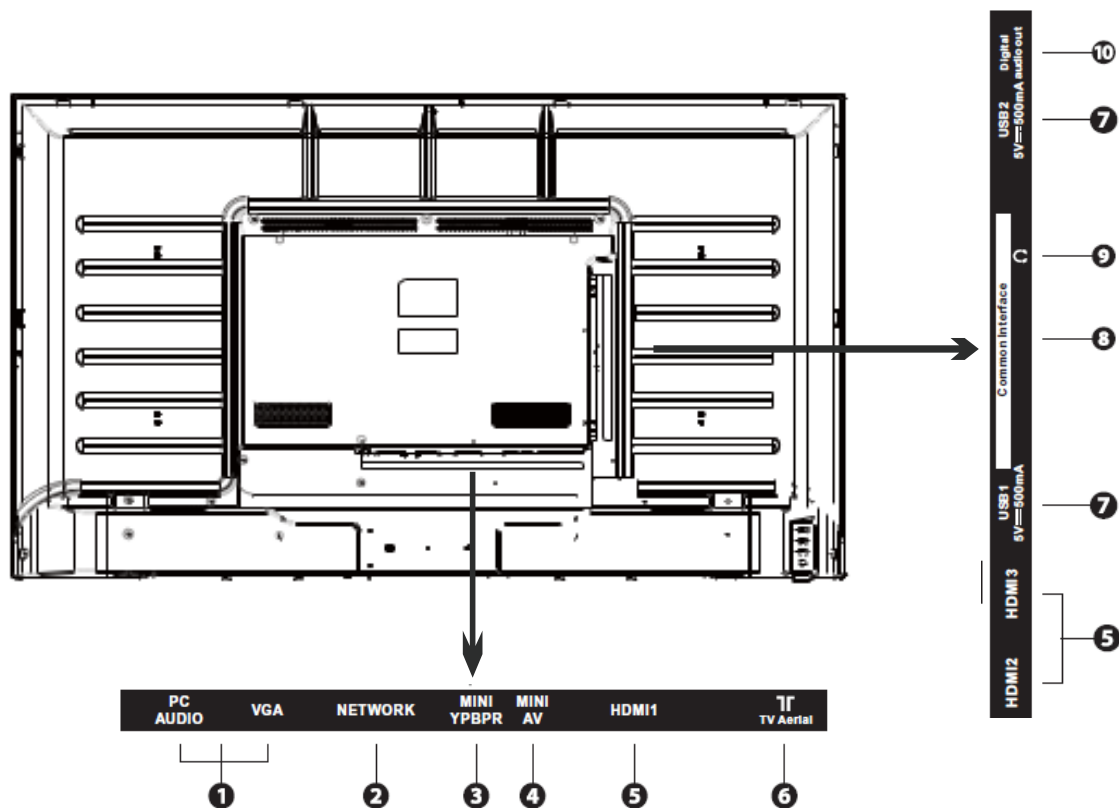

1	VGA / PC AUDIO	Connect to a computer or other device with VGA interface.
2	Network	RJ45 connector to connect between the TV and internet Router
3	Mini YPbPr	Connect devices with component video and audio outputs.
4	Mini AV	Connect devices with composite video and audio outputs
5	HDMI	Connect HDMI sockets on devices such as game consoles and DVD player
6	TV Aerial	Connect the TV aerial
7	USB	Play video audio and text files and use as storage for recordings
8	Common Interface	Allows the insertion of the a Common Access Module.
9	Headphone	Headphone/Earphone connector
10	Digital Audio out	Connect an Optical audio cable

Remote control:

Dependant on the model of TV, some keys will have no function

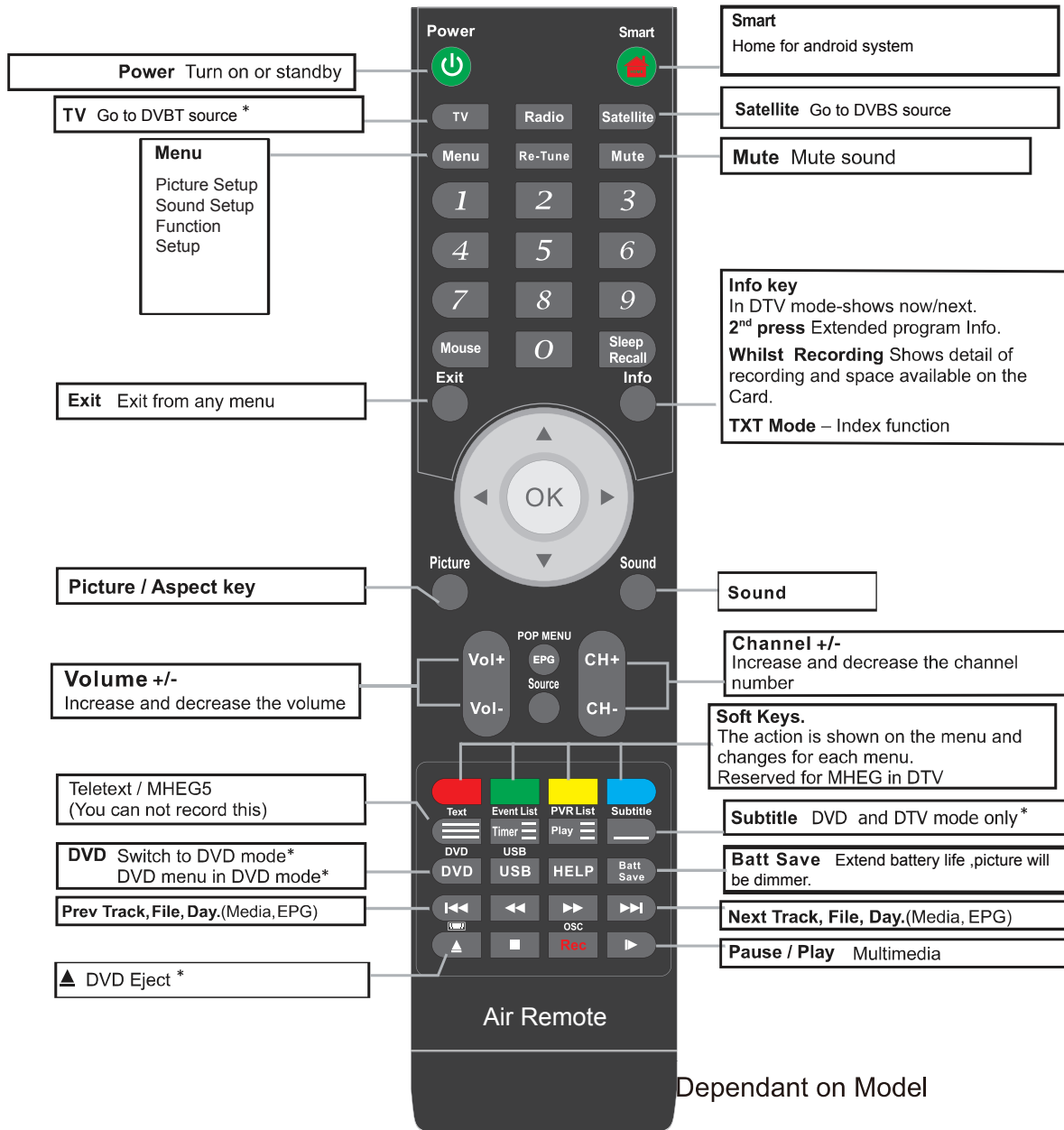

Remote control:

Dependant on the model of TV, some keys will have no function

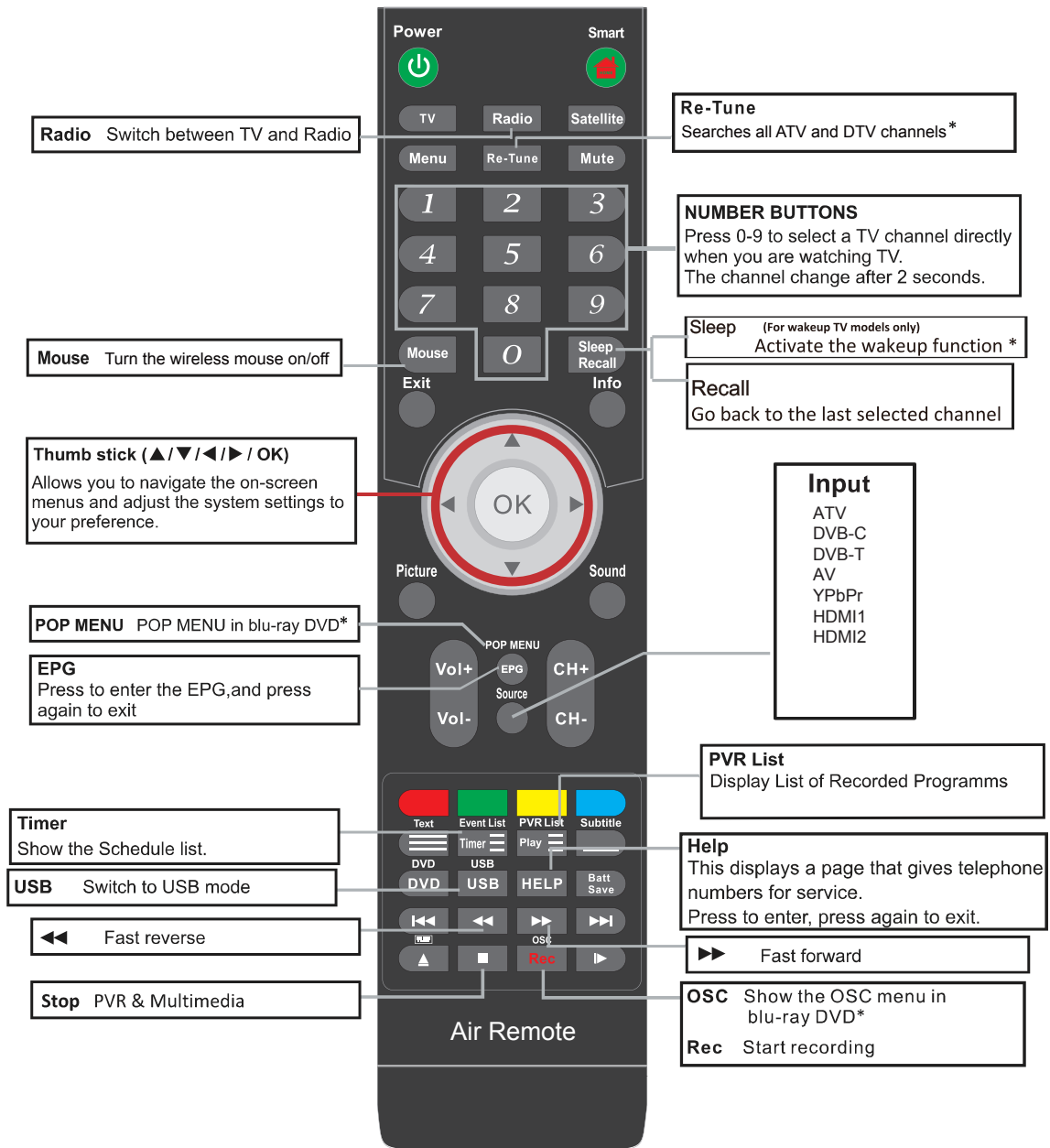

*Dependant on Model

The Mouse cursor is turned on and off by pressing the Mouse key.

Installing Batteries into the Remote Control

Plug in the TV and wait for the TV to power on and show a picture on the screen before inserting the batteries. This enables the wireless remote control to pair correctly with the TV.

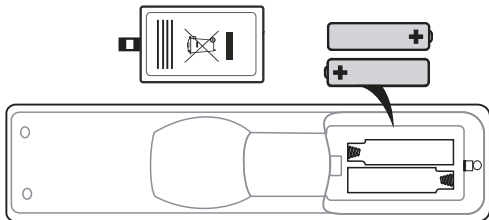

1. Insert 2 x 1.5V AAA batteries making sure to match the (+) and (-) ends of the batteries with the (+) and (-) ends shown in the batterie compartment.
2. Close the batterie compartment cover.



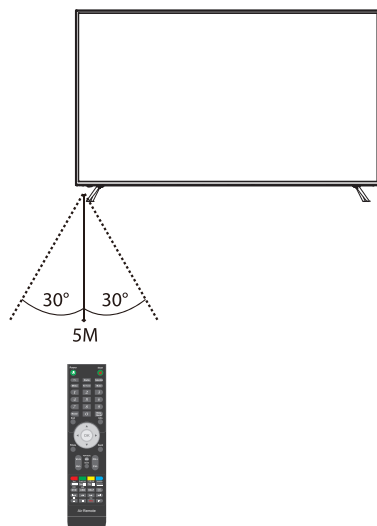



The Remote-Control Operation Range



5 Meters is the normal distance recommended between the Remote control and the TV IR sensor and within 60° in front of the TV (See diagram). The operating distance may vary depending on the brightness of the room.

Video and Audio Connections

This TV supports High-Definition Multimedia Interface (HDMI) and High-Bandwidth Digital Content Protection (HDCP) Protocol.

Best Video Performance ↑		Signal Type	Seperate Audio Connection Required
	 HDMI	HDMI (480i/480p/576i/576p/720p/1080i/1080p)	No
	 VGA	PC	Yes  PC AUDIO
	 Mini YPbPr	Component Video (480i/480p/576i/576p/720p/1080i/1080p)	Yes  Mini AV
	 Mini AV	Composite Video	No

Always connect a device to the TV with the highest quality connection available. Also, use good quality cables to ensure a good transfer of picture and sound. An HDMI connection has the best picture and sound quality. One HDMI cable combines video and audio signals.

Connecting an AV device with an HDMI cable

Audio/Video devices:

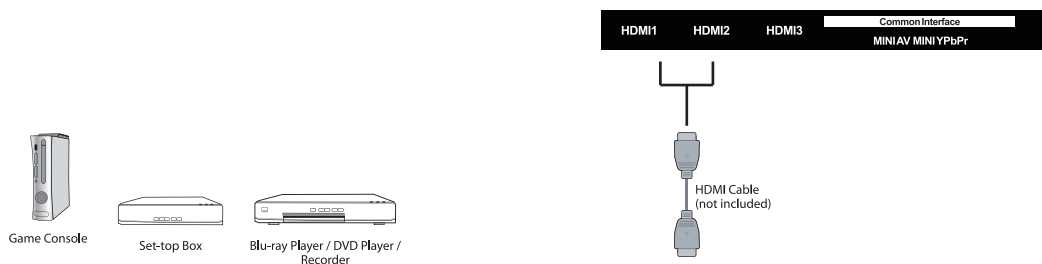

After connecting to an external device (Blu-ray disc player, Game console, Set-top box, or personal computer) with the HDMI cable. Select the HDMI in the source menu and the TV will automatically detect the resolution coming from the device. For the best picture quality adjust the device output resolution up to 3840 x 2160p.

Connecting a Digital Audio Receiver

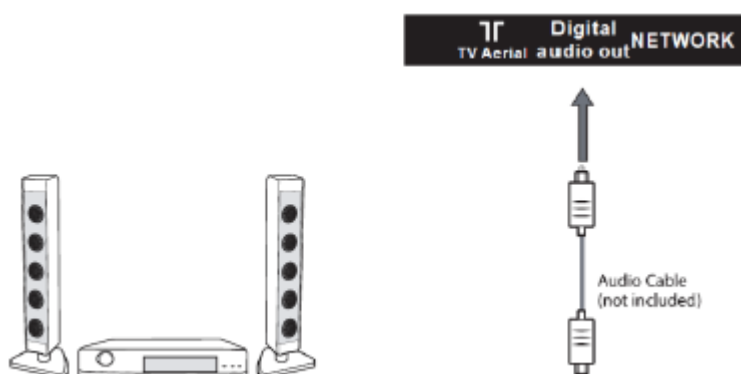

For a better sound quality, you may want to listen to the TV audio output through your Home Sound System or Sound bar. The TV is fitted with an Optical Digital Audio Output. When purchasing a cable, it must be an Optical cable. When the Optical cable is connected to both devices select the source mode optical on the Sound system or Sound bar.

Connecting a USB Storage Device

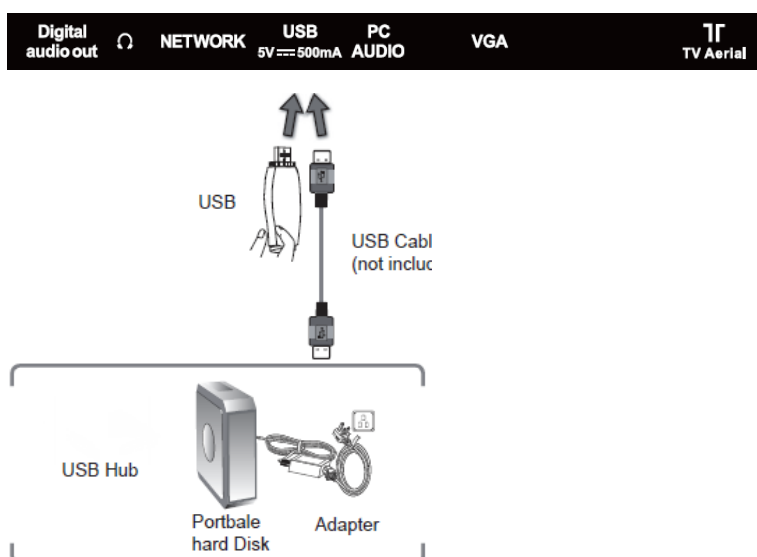

1. Switch off the TV before connecting any USB device
2. Connect the USB storage device to the USB power of the TV
3. Press the power button on the TV or the power key on the remote control to turn the TV on.
4. Press the smart key on the remote control to show the smart home screen. In the source options select Media to view files on the USB device.

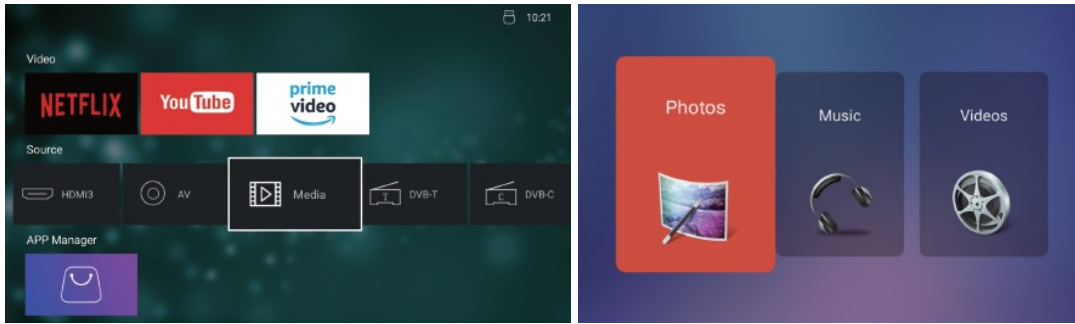

- If a hard disk is used, make sure its mains adapter is connected to the mains supply.
- If a USB hub is used, make sure its mains adapter is connected to the mains supply as the total current consumption may exceed 500mA.
- The maximum tested supported storage space of the hard disk is 1TB.
- The file system only supports Hi-Speed FS, FAT16, FAT32, NTFS formats (NTFS Compressed files are not supported).
- If you want to store the video streaming of a DTV programme, the transfer rate of the USB storage device must not be less than 5MB/s, otherwise the picture and sound of the programme will be affected and a warning message will be shown on the screen. If this happens, please upgrade your USB storage device.
- Disconnect the USB storage device if it is not in use.
- USB output: DC 5V 500mA

Powering on the TV for the first time

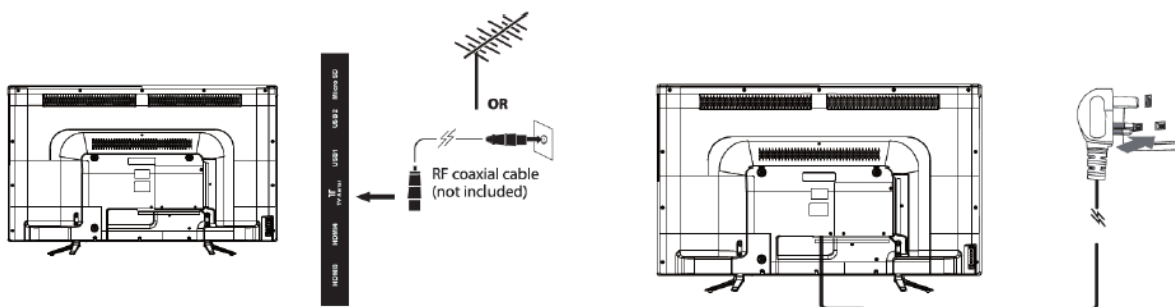

Connect the TV aerial to the TV aerial (RF) connector on the TV and to the TV house aerial connector on the wall.

Connect the TV to the house mains supply with the 3-pin plug. Turn on the TV by pressing the Power key on the remote control or the Standby button on the TV.

So that the wifi remote connects correctly with the TV point the remote control at the TV and insert the batteries. The red led light on the remote control will flash red for a few seconds then you will see the air mouse cursor on the screen. The mouse can be turned on and off by pressing the mouse key on the remote control.

First-time Start up Installation Wizard

It is recommended to turn the mouse cursor off and use the OK key and navigation keys on the remote control to quickly manoeuvre through the Wizard. The Wizard is defaulted to UK settings.

Note all options are selected by pressing the right-side navigation key on the remote control.



1. Language
2. Time zone
3. Network (All WIFI options will be shown on the screen. Select the one you want and if applicable type in the password to activate, once connected continue with the right-side navigation key)
NOTE: After typing in the password use the remote mouse cursor to click on “connect” to the WIFI.

If the ethernet cable is connected to the RJ45 socket the TV will connect automatically.

4. Home (This is the typical and recommended power saving setting)
5. The Welcome screen offers two options

a) Start TV tuning

b) Start Launcher (Smart home screen)

If **Start TV** is selected scroll down and select DIGITAL AUTO TUNING, press the OK key and the TV tuning will begin.

If Start Launcher is selected the TV tuning will be skipped and the smart launcher homes screen will show.

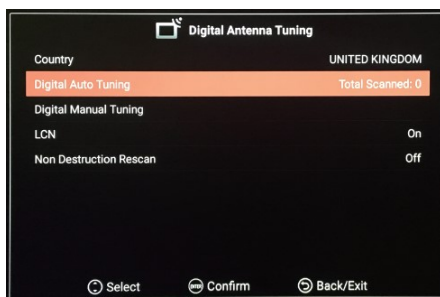
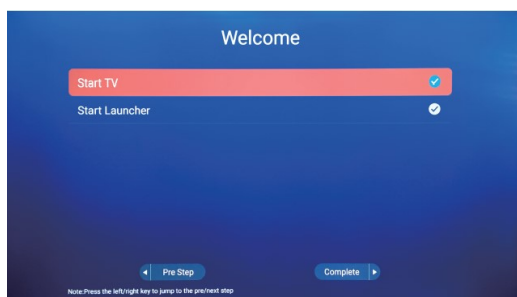

Reset the TV to factory default

If at a later date you wish to reset the TV to factory default settings. **(Please be aware that this option will delete all of your preloaded apps and settings)**

Press the smart key on the remote control to return to the launcher home screen then select the System Settings icon. Then select the option Common.

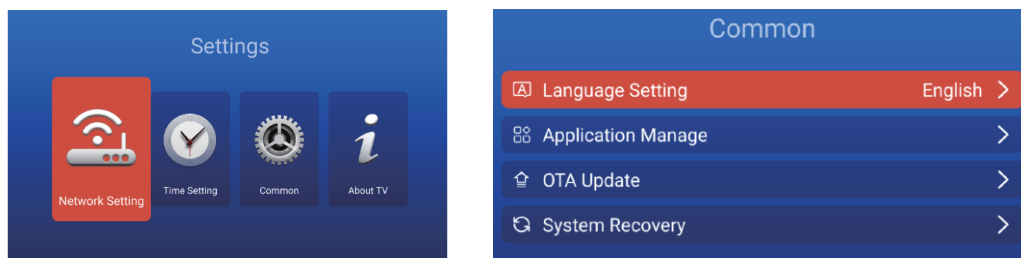

Scroll down and select the option System Recovery, now select Factory Data Reset everything. The TV will restart with the First-time Installation Wizard.

Selecting the Input Source

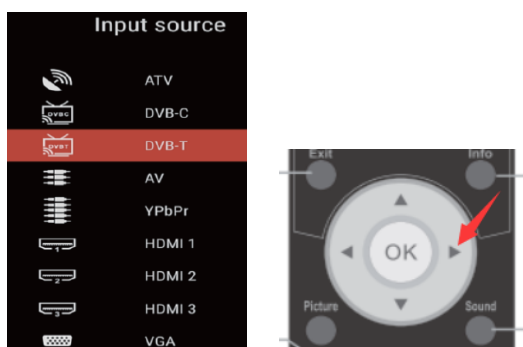

1. Press the Source button on the TV or the Source key on the remote control to display the input source list.
Press the up/down navigation keys on the remote control to select the input source that you want. Choose from: ATV, DVB-C, DVB-T, AV, YPbPr, HDMI 1/2/3, VGA.
2. Press the OK key on the remote control to confirm your selection.

Channel selection options

1. Use the Ch+/- key on the remote control to go up and down the channels
2. Type in the channel numbers using the numeric keys on the remote control. The number being typed in will appear top left of your screen in red. After a few seconds the TV will tune to the chosen channel. This process can be accelerated by pressing the OK key on the remote control after the channel number is on the screen.
3. Press the OK key on the remote control to display the channel list. Using the up/down navigation keys on the remote control to scroll to the channel you require. Press the OK key on the remote control to activate.

Display Channel Information

1. Press the Info key on the remote control to display the channel information.

Volume Adjustment

1. Press the Vol+/- key on the remote control to increase and decrease the volume on the TV.
2. Press the Mute key on the remote control to turn off the sound completely. Once the sound is muted. Press the Mute key or the Vol+ key on the remote control to deactivate the mute function.

Picture Options in DVB-T mode (Television)

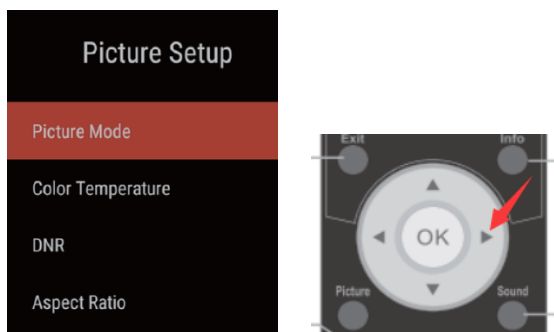

To navigate all menus, use the up/down/left right navigation keys on the remote control. Press the EXIT key on the remote control to return to previous menu.

1. Press the menu key on the remote control to activate the main menu
2. Select Picture setup and activate with the OK key on the remote control
3. **Picture mode:** Select from Standard/Dynamic/Mild/User
4. **Colour Temperature:** Select from
 - Normal
 - Cool (Increases blue tint)
 - Warm (Increases red tint)
5. **DNR:** Select from Off/Low/Middle/High/Auto
6. **Aspect Ratio:** Select from 4:3/16:9/Auto/Zoom1/Zoom2

Sound Options in DVB-T mode (Television)

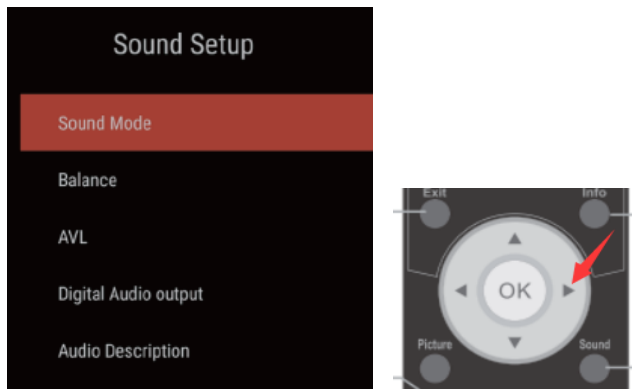

To navigate all menus, use the up/down/left right navigation keys on the remote control. Press the EXIT key on the remote control to return to previous menu.

1. Press the menu key on the remote control to activate the main menu
2. Select Sound setup and activate with the OK key on the remote control
3. **Sound Mode:** Select from Standard/Music/Movie/User
4. **Balance:** Using the left/right navigation key select your preference of audio balance
5. **AVL:** This feature automatically adjusts the audio level when the TV is turned on
6. **Digital Audio Output:** Select the spdif mode from OFF/PCM/Auto
7. **Audio Description:** Turn ON/OFF the Audio Description and set the Audio level

Channel Setup (TV, DTV or Radio Mode)



To navigate all menus, use the up/down/left right navigation keys on the remote control. Press the EXIT key on the remote control to return to previous menu.

1. Select the **country** you are residing in

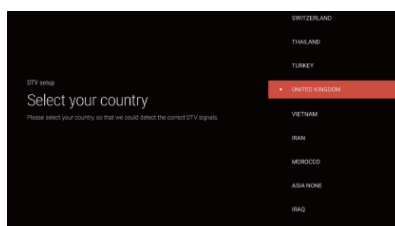

2. Select **Auto Scan** to re-tune the TV channels

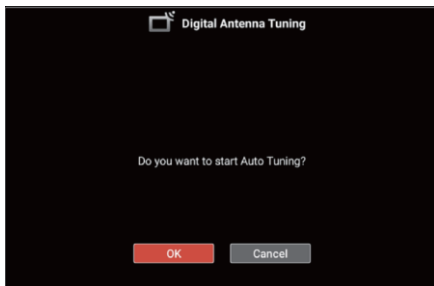

Press the OK Key on the remote control to start the TV channel tuning. Select Cancel to exit the Auto tune.

3. Select **DTV Manual Scan** to manually tune in TV channels



How to search Digital channels manually

The TV channel signal strength and quality indicators are at the bottom of the picture

- Select a channel number
- Select Start Scan to begin the manual search

4. **Channel Edit**

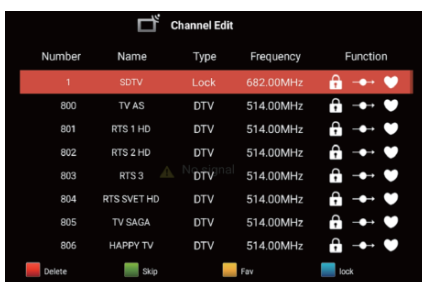

Edit all TV channels with the help of the edit options Delete/Fav/Skip/Lock

- Delete:** Press the red key on the remote control to delete a channel
- Fav:** Press the yellow key on the remote control to add the highlighted channel to the favourite list
- Skip:** Press the green key on the remote control to enable the skip function. If enabled the chosen channel will be skipped when scrolling through the channel list
- Lock:** Press the blue key on the remote control to lock the channel. The channel will be password protected

Important note: Lock feature needs to be activated and password set in the Function menu before the Lock feature can be used. Read Function options.

5. **Common Interface:** Displays Information of any inserted CI module (Card)
6. **DTV Setting**
 - a. **Subtitle language:** Select subtitle language
 - b. **Subtitle type:** Select from Normal or Hard of Hearing
 - c. **Audio type:** Select from Normal or Hard of Hearing
7. **Multi-Audio:** Select from the list of languages available

Function

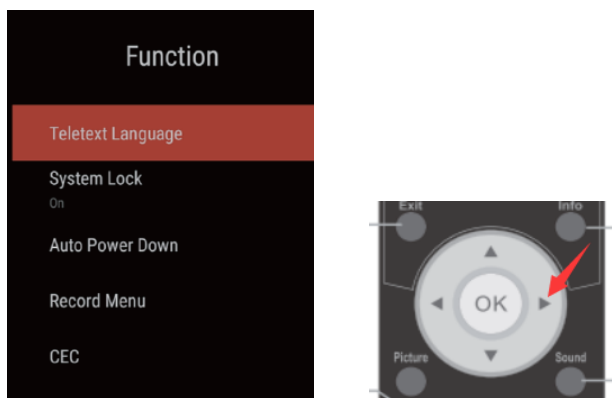

To navigate all menus, use the up/down/left right navigation keys on the remote control. Press the EXIT key on the remote control to return to previous menu

1. **Teletext language:** Select from West Europe/East Europe/Russian/Arabic
2. **System Lock:** Press the OK key on the remote control to turn the lock system on and off

Important note: The default password is 0000. After changing the password please make sure to remember it. If you do forget your password the override password is 8899

- a. **Change PIN:** Use this option to change your password
 - b. **Program restrictions:** This turns on the parental lock to set the age level of your choice to watch the channel. Select None to turn the parental lock off
3. **Auto Power Down:** The TV will power down if no activity on the TV or remote within the duration selected. Select from Off/1hr/2hr/3hr/4hr. The TV default setting is 4hr. Deactivate this function by selecting OFF
 4. **Record Menu**
 - a. **Record Disk Select:** Select the device used to record on
 - b. **Time-shift config:** Turn on/off the Time-shift function
 - c. **Start recording:** Start instant record, select from recording durations, 10min/30min/1hr/3hr/End when device is full/ End when programme ends
 - d. **Scheduled List:** View and edit scheduled recordings
 - e. **Recorded List:** View and playback available previous recordings

5. CEC

Various options to control HDMI ports: turn the CEC ON/OFF

Setup

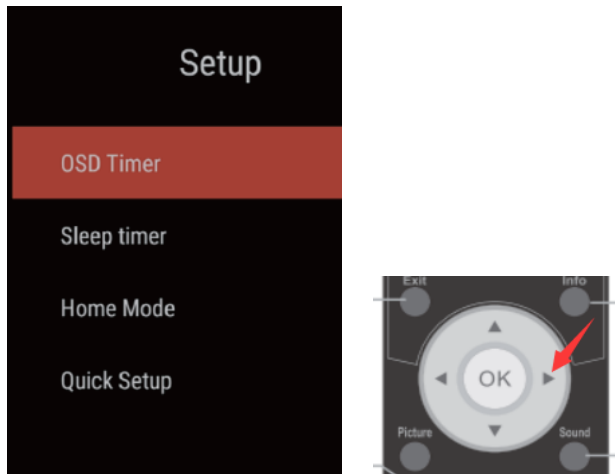

To navigate all menus, use the up/down/left right navigation keys on the remote control. Press the EXIT key on the remote control to return to previous menu

1. **OSD Timer:** Select options of the duration the menus remain on screen from 10s/20s/30s/40s/50s/60s/Off
2. **Sleep Timer:** The TV will automatically go to standby if the sleep timer is set. Select from options Off/15min/30min/60min/90min/120min/180min
3. **Home mode:** Select from Home/Max Brightness
4. **Quick Setup:** Reset the TV for TV tuning

Smart Features (Launcher screen)

Launcher screen

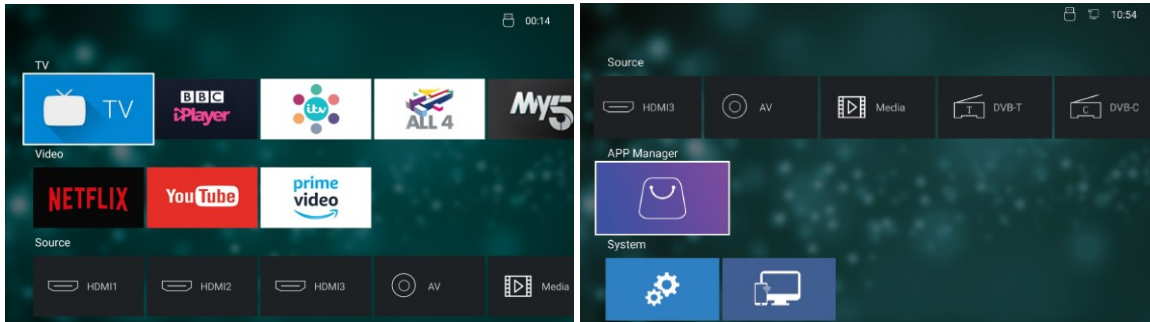

Top

Bottom

The TV on demand apps and streaming apps are listed in the top two rows.

TV apps: BBCiplayer/ITVHub/All4/My5/UKTVPlay

Streaming apps: Netflix/YouTube/Amazon prime Video

The apps are not pre- installed and you will need to install them by simply highlighting the app you want to install and pressing the OK key on the remote control. Press the OK key again to activate the download, the app will then download and install automatically.

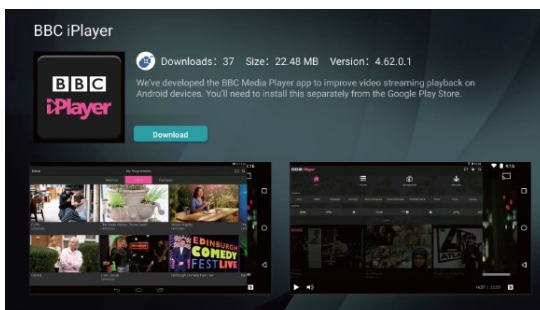

App manager

The app manager is on the 4th row down and shows you what apps are installed and if any app updates are available.

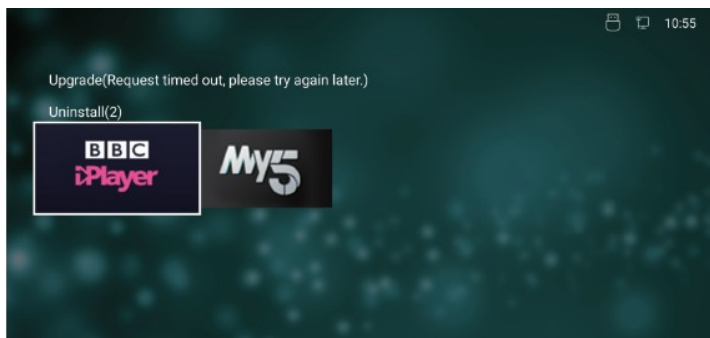

In this folder is also the option to uninstall any app. Uninstall by highlighting the app and press the OK key on the remote control. Select OK to uninstall.

If any updates are available, they will be in the app manager. If you find that an app is not opening on the home screen, please check the app manager for any updates.

To activate **Netflix** or **Prime video** you will need to have a Netflix and or an Amazon account with login details (user name and password)



YouTube will function normally but it is not possible to sign into a google account

TV App

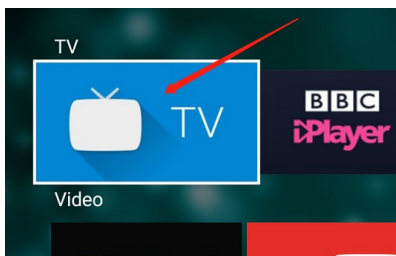

The TV link is a direct link to your television channels.

Screen Mirroring

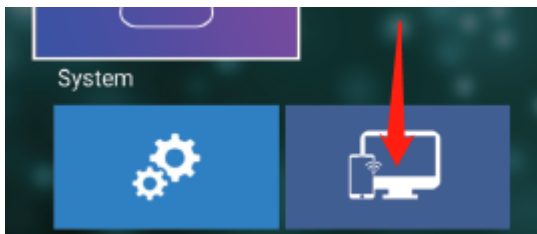

Highlight the Screen mirroring app then press the OK key on the remote control to activate. Now you can cast phones/Laptop/Tablets to the big screen

Note: The device and the TV must be connected to the same WIFI source

System settings

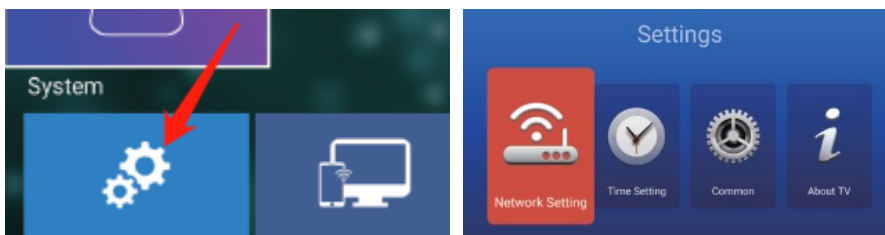

Highlight and press OK on the remote control to activate system settings

Network Settings

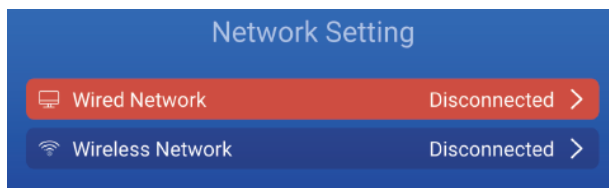

Highlight and select with the OK key on the remote control to open the wired and WIFI network settings.

Time Settings

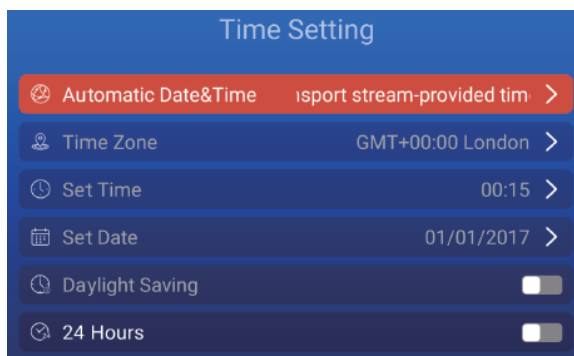

Highlight and select with the OK key on the remote control each option to set your preferences.

Common settings

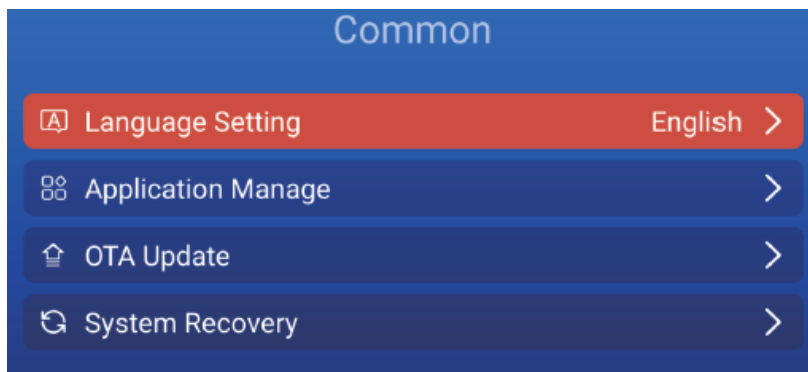

Highlight and select with the OK key on the remote control each option to set preferences.

OTA Update: If any updates are available for your TV you will receive an upgrade prompt when you start up your TV. If you want to check manually then select OTA Update.

Note: The update will not delete any apps or personal settings.

System Recovery: To do a factory data reset select System Recovery, this will put the TV software back to factory default settings.

Note: Be aware that this process will delete all personal settings and all apps will need to be reinstalled.

Maintenance

Be sure to disconnect the mains plug before cleaning the TV.

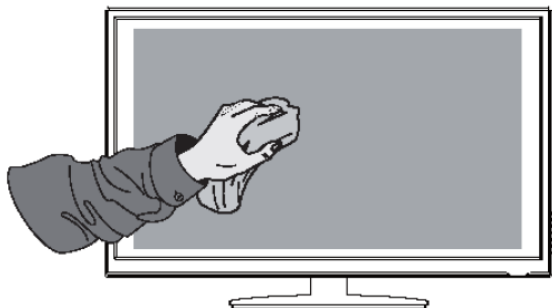

1. Use a soft dry cloth to wipe away the dust from the screen and plastic surfaces
2. Use warm soapy water to get rid of stubborn marks. Soak the cloth then wring it until almost dry before wiping the TV.
3. After cleaning allow any dampness on the screen to dry before switching on the TV

Important Note:

1. Never use alcohol, benzene, paint-thinner, cleaning fluid or other chemicals
2. Do not use compressed air to remove dust

Trouble shooting

Warning

Under no circumstances should you try to repair the TV by yourself, as this will invalidate the warranty. Do not remove the rear cabinet of the TV as there is a risk of electric shock. If a fault occurs, first check with the points listed below before calling the service help line (03334330312) for assistance.

Problem	Solution
No power	-Check if the power cable is connected correctly -Press the power key on the TV to turn on the power
TV does not respond to the remote control	-Aim the remote directly at the sensor on the TV -Reduce the distance to the TV -Aim the remote at the TV sensor and remove and replace the batteries.
TV freezes	-The processor may have crashed, turn the TV off at the mains and re-start the TV. If freezing persists, call the help line.
TV turns itself off	-Check that the sleep timer is not set to turn off -Check that the screensaver option "Put device to sleep" is set to Never. Default setting is 3hrs

Technical Specifications

Screen size and system	40" LED
Max Screen resolution	1920 (H) x 1080(V)
Screen Brightness	200 Nits
Contrast Ratio	5000: 1
Power Source	AC 100-240V
Processor	A53 quad core CPU @900MHz
RAM	1GB DDR4
GPU	5 core ARM Mali-470
Built in Flash memory	8GB
Operating System	Android 7.1
Energy Efficiency Class	A
Average Annual Energy Consumption	82kWh
Speaker power	8W + 8W
Vesa wall mounting size / Screw size	200 x 200mm / M5 x 6
Dimension (W x D x H) without stand feet	883.4 x 85.6 x 521.3mm
Dimension (W x D x H) with stand feet	883.4 x 216.3 x 563.2mm
Net Weight	5.9Kg

Safety Warnings

- Read all the instructions carefully before using the TV and keep them for future reference
- If you pass the TV onto a third party make sure to include this instruction manual
- Make sure that the voltage marked on the black rating label on the rear of the TV matches your mains voltage

Safety

- Always disconnect the unit from the mains supply before connecting / disconnecting other devices or moving the TV
- Unplug the TV from the mains socket during a lightning storm

Mains Cable

- If the mains cable is damaged it must be replaced by the manufacture, its service centre, or similarly qualified persons in order to avoid a hazard

Damage

- Inspect the TV for damage after unpacking

- Do not continue to operate the TV if you are in any doubt about it working normally, or if it is damaged in any way – switch off, disconnect from the mains supply and call the service help line

Interference

- Do not place the TV on or near appliances which may cause electromagnetic interference. If you do it may adversely affect the operating performance of the TV and cause distorted picture or sound

Optimum Viewing

- View the TV in moderate light to prevent eye strain. It is recommended to watch the TV from a distance 3 – 7 times the screen height

LED Screen

- The LED /QLED screens are manufactured using high precision technology. However, some tiny black dots/ or bright dots (red, blue, or green in colour) may constantly appear on the screen. These points are generated in the LED Screen manufacturing process.

Location

- The TV must be placed on a flat stable surface and should not be subjected to vibrations
- The mains socket should be located close to the TV and should be easily accessible
- This TV is designed for indoor use only

Temperature

- Avoid extreme degrees of temperature, either hot or cold. Place the unit well away from heat sources such as radiators or gas / electric fires
- Avoid exposure to direct sunlight and other sources of heat

Naked Flames

- Never place any type of candle or naked flame on the top of or near the unit

Moisture

- To reduce the risk of fire, electric shock or product damage, do not expose to the TV to rain, moisture dripping or splashing. Keep containers such as cups or vases filled with liquids away from the TV.

Ventilation

- To prevent the risk of electric shock or fire hazard due to overheating, ensure that curtains and other materials do not obstruct the ventilation vents.
- Do not install or place this TV in a confined space. Ensure the TV is well ventilated
- Make sure that there is a gap of at least 10cm on both sides and a gap of 20cm at the top

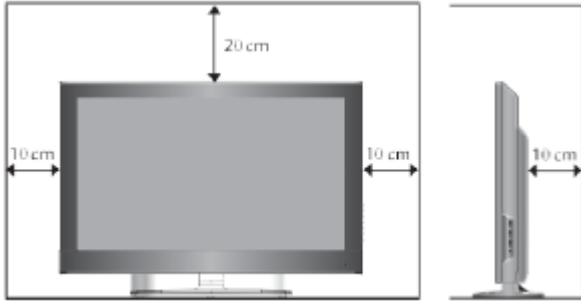

Headphones

- Listening to loud sounds for prolonged periods of time may permanently damage your hearing

Batteries

- Please keep the batteries for the remote control away from young children
- Please dispose of the batteries correctly by following the guidance in this manual

Electronic waste recycling



■ This sign indicates that this product may not be disposed of with your regular household waste. The recycling and separate collection of such products is your responsibility. Please drop off the above-mentioned waste at a designated place for recycling electronic waste. If you do not know where to drop off, your electronic waste for recycling please contact your local council office or household waste collection service.



Hg Cd Pb The crossed out wheeled bin symbol indicates that batteries and / or accumulators must be collected and disposed of separately from household waste.

If the battery of accumulator contains more than the specified values of Lead (Pb), mercury (Hg), and/or cadmium (Cd) defined in the Battery directive (2006/66/EC), then the chemicals symbols for Lead (Pb), mercury (Hg), Cadmium (Cd) will appear below the crossed out wheeled dust bin symbol



Pb By participating in separate collection of batteries, you will help to assure the proper disposal of products and batteries thus help to prevent potential negative consequences for the environment and human health.

For more detailed information about the collection and recycling programmes available in your country, please contact your local city or council office.



This appliance complies with the European Safety and Electrical directives.

It fulfils the following EU regulations:

EMC Directive 2014/30/EU

Test Standards:

EN55032:2015

EN55035:2017

EN61000-3-2:2014

EN61000-3-3:2013

LVD Directive 2014/35/EU

Test Standards:

EN 60065:2014