

# Traveller TV



Instruction Book



---

## Contents

<b>SAFETY INFORMATION.....</b>	<b>3</b>
Headphone Warning.....	4
Where to install.....	4
LED Screen.....	4
<b>Unit and Accessories.....</b>	<b>5</b>
Unit and Started.....	5
Front view.....	5
<b>Remote Control.....</b>	<b>7</b>
Remote control instructions.....	7
Remote control instructions.....	8
Installaing Batteries in the Remote Control.....	9
Using the Remote Control.....	9
<b>Aerial connection.....</b>	<b>9</b>
Connecting the TV Antenna.....	9
<b>Connecting external devices.....</b>	<b>9</b>
HDMI Lead.....	9
SCART Lead.....	9
VGA Cable.....	9
<b>CONNECTIONS.....</b>	<b>11</b>
PC connection.....	11
VGA,HDMI PC Connection.....	11
Satellite connection.....	11
Connecting an audio syatem.....	12
Connecting a DVD player.....	13
HDMI Connection.....	13
SCART Connection.....	13
USB Connection.....	13
AV Connection.....	14
YPbPr Connection.....	14
First Time Installation.....	15
Input Source.....	16
Picture Setting.....	17
Sound Setting.....	18
Channel Setting.....	19
Lock Setting.....	24
Time Setting.....	26
Option Setting.....	27
<b>Connecting a USB Storage Device.....</b>	<b>28</b>
<b>Multimedia Operation.....</b>	<b>29</b>
Phone.....	30
Music.....	30
Movie.....	31
Text.....	31
<b>DVD Operation.....</b>	<b>32</b>

---

<b>TROUBLE SHOOTING GUIDE.....</b>	<b>35</b>
<b>TECHNICAL SPECIFICATIONS.....</b>	<b>35</b>
<b>Wall Mounting.....</b>	<b>36</b>
<b>Waste Electrical Recycling.....</b>	<b>36</b>

---

## Introduction

Thank you for purchasing this LED TV which has been designed and manufactured to give you many years of trouble free service.

You may already be familiar with using a similar product but please take time to read these instructions which have been written to ensure you get the very best from your purchase.

## HDMI

HDMI (High Definition Multimedia Interface) is the next generation of digital interface. Unlike conventional connections, it transmits uncompressed digital and audio signals using a single cable. This TV supports high-definition video input via the HDMI socket on the back of the TV.

## Safety is important

To ensure your safety and the safety of others, please read the safety precautions BEFORE you operate this product.

## Disclaimer

The illustrations of the LCD-TV, accessories and menus shown in this User's Manual may differ from the actual product.

## SAFETY INFORMATION

IMPORTANT SAFETY INSTRUCTIONS - READ CAREFULLY BEFORE USE.

Take note of the following safety information which appears on the back of the TV.



CAUTION: TO PREVENT ELECTRICAL SHOCK, DO NOT REMOVE ANY COVER SCREWS, NO USER SERVICEABLE PARTS INSIDE, REFER SERVICING TO QUALIFIED SERVICE PERSONNEL.



This symbol indicates that there are important operating maintenance instructions in the literature accompanying this unit.



This symbol indicates that dangerous voltage constituting a risk of electric shock is present within this unit.

Keep these instructions

- Do not use this TV near water.
- Clean only with a slightly damp cloth.
- Do not block any ventilation openings.
- Install in accordance with the supplied Quick Start Guide and this User Guide.
- Protect the power chord from being walked on or pinched, particularly at plugs, and the point where it exits from the TV.
- Do not allow the power chord to overhang the edge of a table.
- Unplug this TV during lightening storms or when unused for long periods of time.



WARNING! TO REDUCE THE RISK OF FIRE OR ELECTRICAL SHOCK, DO NOT EXPOSE THIS TV TO RAIN OR MOISTURE. THE TV MUST NOT BE EXPOSED TO DRIPPING AND SPLASHING AND NO OBJECTS FILLED WITH LIQUIDS SHOULD BE PLACED ON THE TV.

NOTE: No naked flames such as candles should be placed on the TV.

NOTE: When displaying the same still picture for more than 2 hours without any interruption, the picture contours of the continuously displayed contents may remain visible on screen, i.e. a persistent image remains. The same applies, when displaying for more than 2 hours:

- the same background/wallpaper
- logos, video games, computer images, Teletext
- contents with a non-filling aspect ratio (e.g. 4:3 format)

These do not represent any malfunction and will not be covered by the manufacturer's warranty

---

This unit has been produced according to all current safety regulations. The following safety tips should safeguard users against careless use and the dangers connected with such use.

- Although this appliance has been carefully manufactured and rigorously checked prior leaving the factory, as with all electrical appliances it is possible for problems to develop. If you notice smoke, an excessive build up of heat or any other unexpected phenomena, you should disconnect the plug from the mains power socket immediately.
- Ensure that the unit is sufficiently ventilated! Never place next to or underneath curtains!
- The mains plug or appliance coupler is used as the disconnect device, the disconnect device shall remain readily operable.
- This set should only be connected to a mains power supply which matches that stated on the label on the rear of the TV - do not attempt to connect it to any other type of supply.
- The socket - outlet must be installed near the equipment and easily accessible.
- To prevent overload, don't share the same mains supply socket with too many other items of equipment.
- Apparatus with Class 1 construction shall be connected to a mains socket outlet with a protective earth connection.
- Keep away from rodents. Rodents enjoy biting into electric flexes.
- Always hold the plug when pulling out the plug from the mains supply socket. Do not pull on the flex, the flex can become overloaded and cause a short circuit.
- Set up the unit so that no one is able to trip over the flex.
- Do not place heavy items on the flex, which may damage it.
- Take note that the flex cannot be reached and pulled by young children, avoiding injury.
- Do not set up the unit near to heat sources. The casing and the flex could be damaged by the impact of heat.
- The screen is made of plastic and can break if damage is done to it. Be careful when collecting sharp edged plastic splinters to avoid injury.
- Avoid placing the unit on any surfaces that may be subject to vibrations or shocks.
- To protect the unit during a thunderstorm unplug the AC power cable and disconnect the aerial. Caution: Do not touch the aerial (RF) connector.
- When you leave your home for long periods of time, unplug the AC power cable for safety reasons.
- The unit becomes warm when in operation. Do not place any covers or blankets on the unit in order to prevent overheating. The ventilation holes are not to be blocked. Do not set up near radiators. Do not place in direct sunshine. When placing on a shelf leave 5 cm (2") free space around the whole unit.
- Do not allow water or moisture to enter the TV. Do NOT use in wet or moist areas such as Bathrooms, steamy kitchens or near swimming pools.
- Do not use this unit when moisture condensation may occur
- Any repairs must be carried out by qualified personnel only.
- Do not open this unit. A non-expert attempting to repair the unit could be dangerous and potentially cause a fire hazard.
- Liquids spilt into the unit can cause serious damage. Switch the set OFF and disconnect the mains power supply, then consult a qualified service person before attempting to use the unit again.
- Do NOT remove the safety covers. There are no useable or serviceable parts inside. You may invalidate the warranty. Qualified personnel must only service this apparatus.
- Do NOT tap or shake the screen, you may damage the internal circuits. Take good care of the remote control, do not drop.
- Never place hot objects or open flame sources on or close to the TV.
- High temperatures can melt plastic and lead to fires.
- To clean the TV use a soft dry cloth. Do NOT use solvents or petrol based fluids. For stubborn stains, you may use a damp cloth with dilute detergent.

### Headphone Warning



Loud music can damage your hearing irreversibly, therefore do not set the volume to a high level when listening through headphones, particularly for lengthy listening periods.

### Where to install

Locate the television away from direct sunlight and strong lights, soft indirect lighting is recommended for comfortable viewing. Use curtains or blinds to prevent direct sunlight falling on the screen. Place the TV on a sturdy platform of which the surface should be flat and steady. This will prevent it from falling over.

Make sure the television is located in a position where it cannot be pushed or hit by objects, as pressure will break or damage the screen, and so that small objects cannot be inserted into the ventilation slots or openings in the cabinet.

### LED Screen

The LED display panels are manufactured using an extremely high level of precision technology, however sometimes some parts of the screen may be missing picture elements or have luminous spots. This is not a sign of malfunction.

## Unit and Accessories

## Getting Started

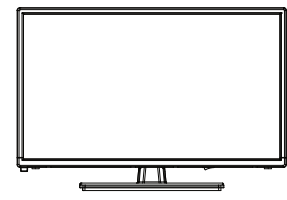

TV set



Remote Control



Batteries for Remote Control

### Front view

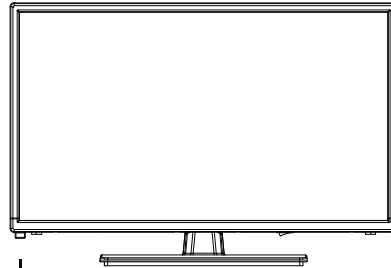

LED Indicator  
Remote Control Window  
(keep clear)



Quick Start Guide

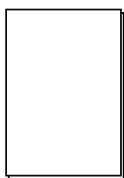

User Guide



Mains adapter



Car adapter



Stand



Screws(supplied)  
5 x ST4 x 12

Packaging materials are not toys. Please keep away from children. Plastic bags can cause suffocation when pulled over the head.

Note about digital TV: Digital TV (DVB) is available only where digital terrestrial television (DVB-T) is broadcast or where a compatible cable TV service (DVB-C) is provided. Please ask your dealer if you need further information about the local availability of these services. DVB-T is the standard for terrestrial digital TV and DVB-C designates the digital cable TV service. Although this TV set conforms with all current DVB-T and DVB-C standards, we cannot guarantee compatibility with any future digital terrestrial DVB-T and DVB-C signals. Some cable TV providers charge additional fees and external hardware is required for their offer, and a subscription for the related services may be necessary. Some digital TV functions may be limited to specific regions and for DVB-C it is possible that the device will not perform as expected with certain providers. For more information, please do not hesitate to contact our Customer Service.

# The parts



TV set

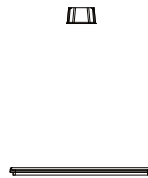

Stand

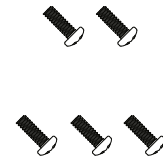

Screws(supplied)  
5 x ST4 x 12

## Installation

**Place the TV face down on a soft and flat surface (blanket, foam, cloth, etc.) to prevent any damage to the TV.**

Put the stand to the neck of the TV set as shown below.

1. Fix the base stand to the TV body as image 1.

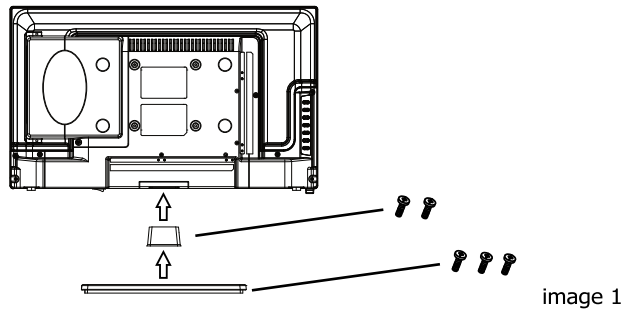

2. Fix the base stand to the TV body with screws.

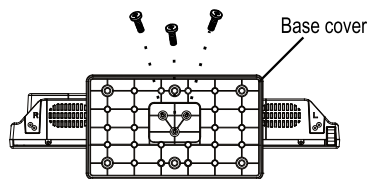

This unit is VESA-Compliant and designed to be wall mounted with a VESA-Compliant 100 x 100mm mounting kit.

Mount this according to the instructions of the wall bracket (not supplied)

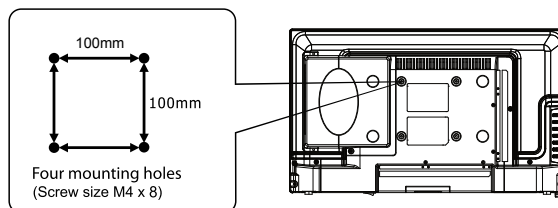



# Remote Control

## Remote control instructions

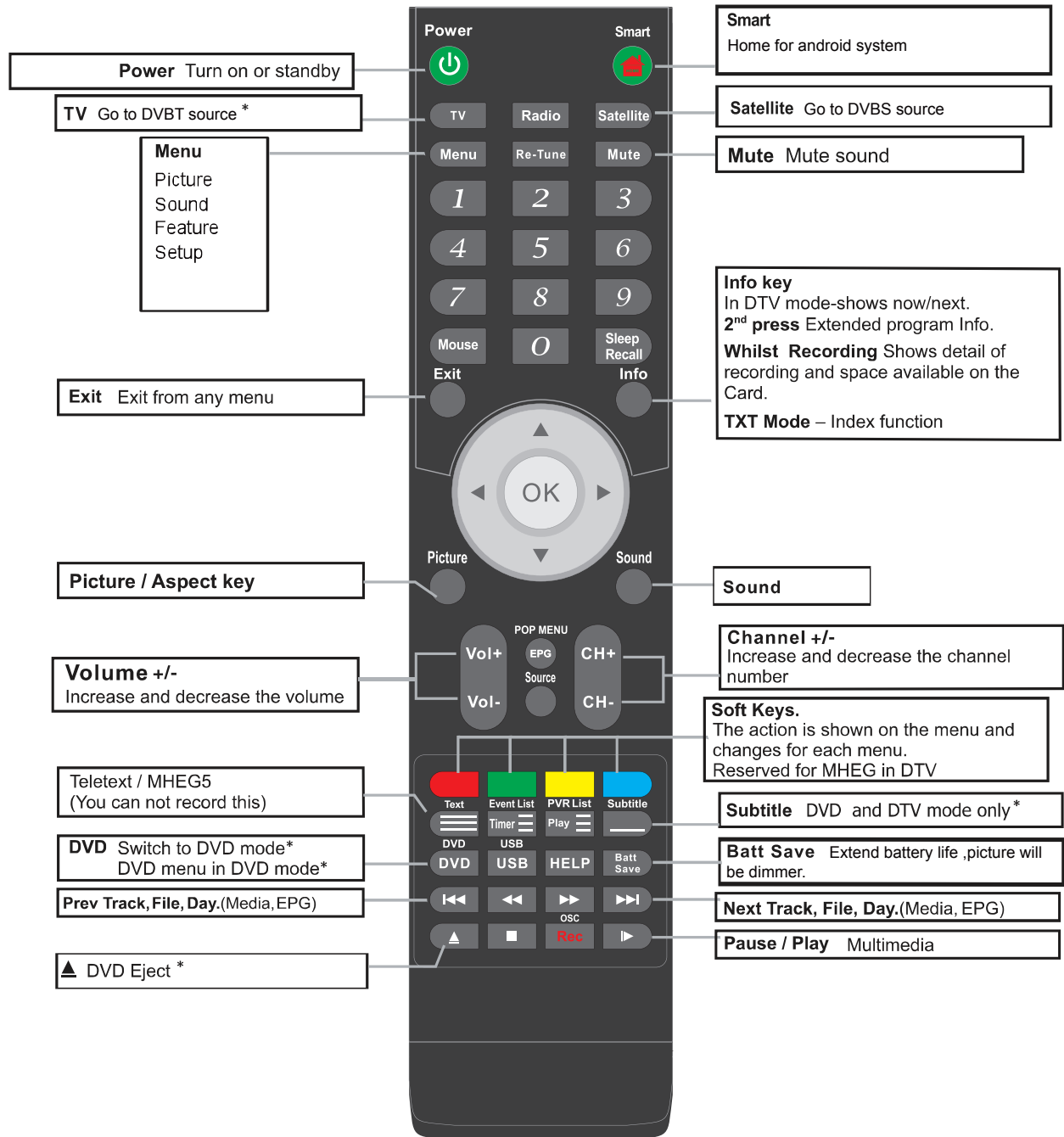

\*Dependant on Model

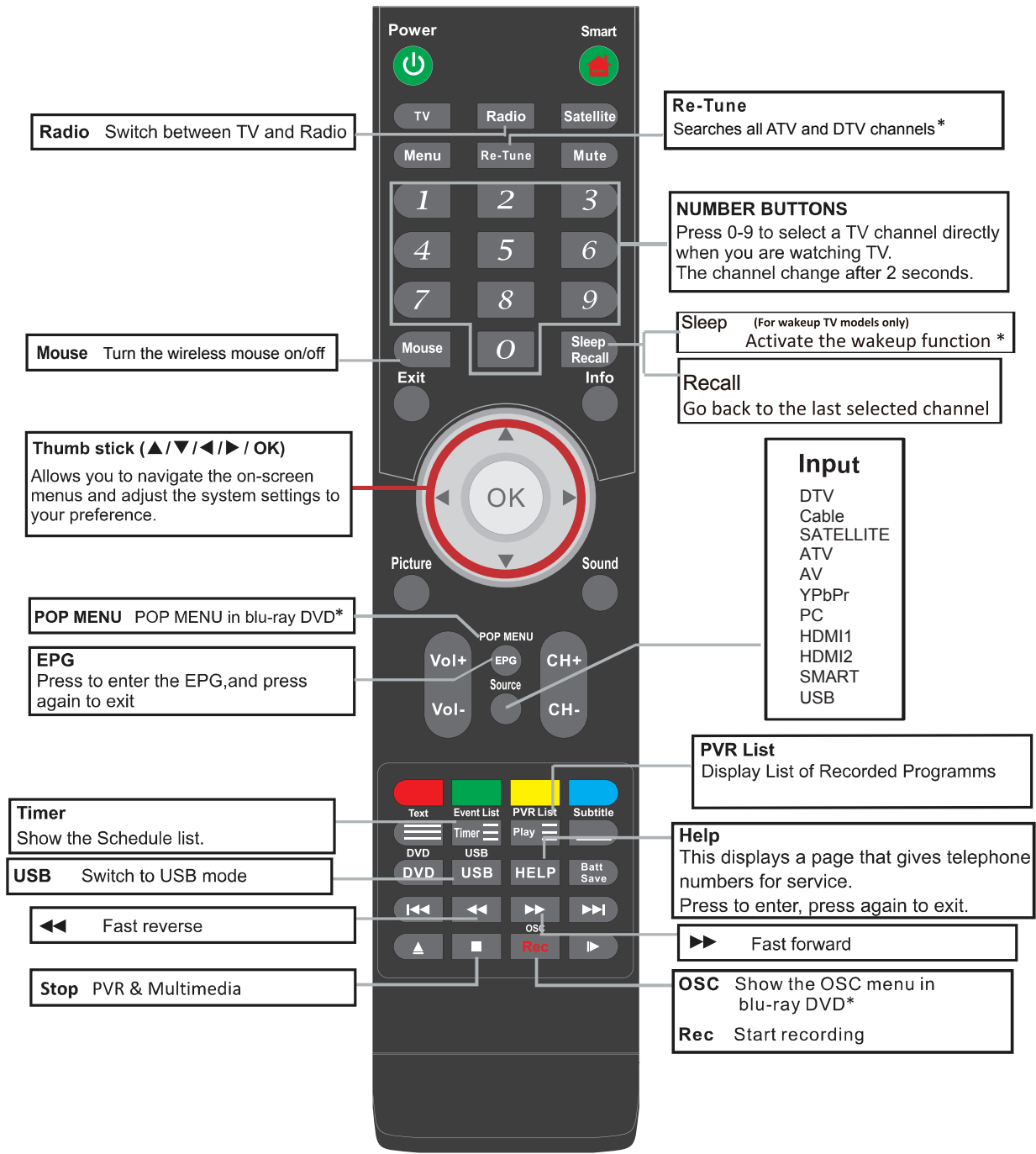

\*Dependant on Model

## Installing Batteries in the Remote Control

1. Remove the battery compartment cover at the rear of the remote control by pushing the retaining clip forward and pulling up.
2. Install the supplied batteries, ensuring the polarity matches what is shown in the battery compartment.
3. Replace the battery compartment cover.

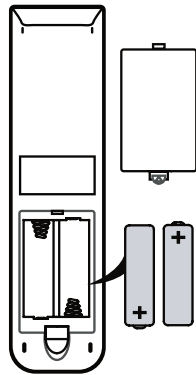

## Using the Remote Control

To use the remote control point it at the TV and press the required buttons. You must be within 6 meters and at an angle of less than 30 degrees from the center of the TV.

**NOTE:** Sunshine or other strong light sources may interfere with the signal from the remote control. In this situation turn the TV away from the light source.



**WARNING!** DO NOT LEAVE BATTERIES IN THE REMOTE CONTROL FOR EXTENDED PERIODS AS THEY CAN LEAK OR CORRODE CAUSING DAMAGE TO THE REMOTE CONTROL. CHECK THEM PERIODICALLY AND REPLACE THEM AS REQUIRED.



**WARNING!** DO NOT MIX BATTERY TYPES. WHEN INSERTING BATTERIES, REPLACE ALL BATTERIES AT THE SAME TIME. DO NOT MIX OLD AND NEW BATTERIES.



**WARNING!** EXHAUSTED BATTERIES MUST BE TREATED WITH CARE AND DISPOSED OF ACCORDING TO ANY SAFETY OR RECYCLING REGULATIONS IN FORCE IN YOUR LOCAL AREA, NEVER DISPOSE OF BATTERIES INTO GENERAL WASTE, OR FIRE.



**WARNING!** NEVER EXPOSE BATTERIES TO EXCESSIVE HEAT SUCH AS SUNSHINE, FIRE OR THE LIKE.

## Aerial connection

**WARNING!** ENSURE THE TV AND ALL ANCILLARY EQUIPMENT IS UNPLUGGED FROM THE MAINS BEFORE MAKING ANY CONNECTIONS!

### Connecting the TV Antenna

Connect the TV antenna to the aerial socket with a 75 ohm co-axial plug. For best results use a high gain TV aerial, preferably roof or loft mounted.

- To improve picture quality in a poor signal area, purchase and install a signal amplifier.
- If the antenna needs to be split for two TVs, use a 2-Way Signal Splitter (not supplied).

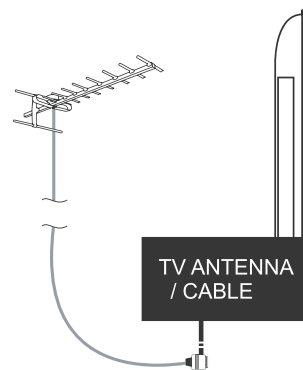

## Connecting external devices

This instruction manual shows the simplest and most effective way of connecting your TV to ancillary equipment. Alternate methods are listed below.

### HDMI Lead

You can connect this TV to a compatible device using a HDMI lead. This method will give the best picture.

Connect the cable from the HDMI equipment to the TV HDMI socket.

### SCART Lead

You can connect this TV to a compatible device using a SCART lead. The connection uses component video signals, i.e. the red, green and blue (RGB) content of the video are sent on separate signals.

### VGA Cable

You can use your TV as a monitor for your personal computer by using a VGA cable. Sound from your personal computer may also be played through the TV.

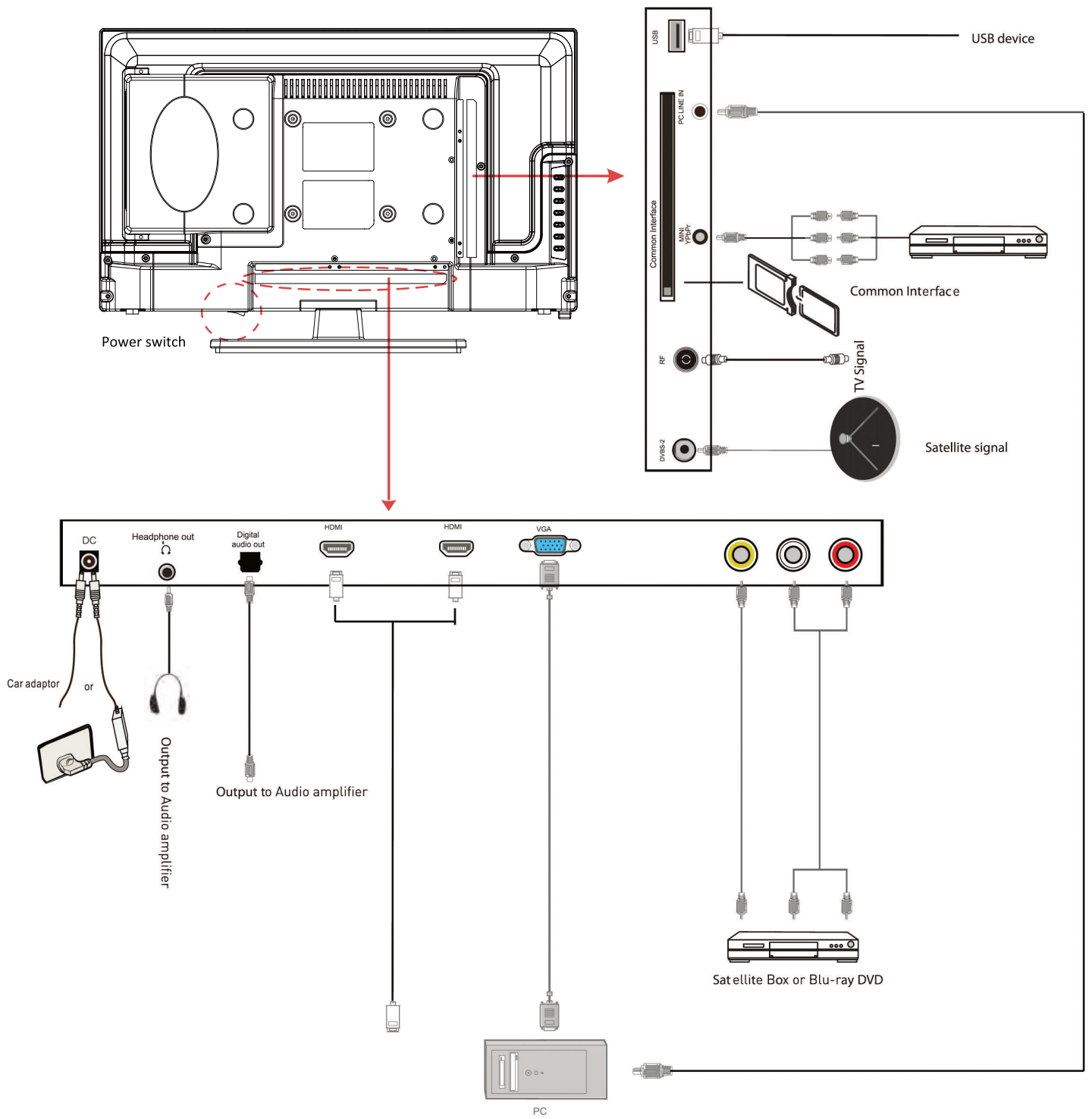

## Connecting external devices (continued)

### CONNECTIONS

Name	Function Description
POWER	Connect to power supply
HDMI	Connect to the HDMI output of your DVD or Satellite Box
SAT LNB Connection	Connect to Satellite signal
VGA (PC IN)	Connect to the PC VGA output to display PC graphics
PC-IN	PC Audio input
Mini YpbPr	Connect to the YPbPr output on external devices
AV	Connect to AV output on external devices
RF	Connect to TV signal cable
Head phone	Connect Head phone
CI / CI+	CI slot (Pay as you view card slot)
Digital Audio Out	Output to audio amplifier
USB	Media playback

#### Caution:

Before connecting external devices:

- Makes sure to disconnect the appliances from the power supply in order to avoid any potential damage from occurring.
- Make sure to establish the required connection.
- Make sure that the connectors are properly and correctly attached before connecting the appliances to the power supply.

### PC connection

As PCs are sometimes still supplied with a 'conventional' CRT monitor, you may need to adjust the display settings of your PCs graphics card, otherwise the pictures may not appear correctly. Switch on your PC (still with your original monitor connected) now select the screen resolution, and select 60Hz refresh rate. Switch off your PC, then connect it to your TV while both appliances are still switched off.

### VGA, HDMI PC Connection

Use a PC-VGA cable (not supplied) to connect the TV to your PC. You can also use an HDMI cable to connect to your PC (if your PC Graphic card supports HDMI). When the HDMI cable is used, the PC audio cable is no longer required. If you use the HDMI to DVI cable, you will need to use the PC audio cable. Connect all cables carefully and do not bend or break the connector pins.

When using the VGA cable

- Switch on the TV
- Switch on the PC
- Select PC/VGA as input source

When using the HDMI cable

- Select HDMI as input source

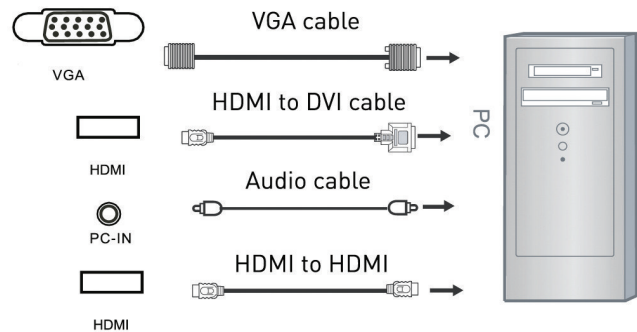

(All illustrated cables are not supplied)

### Satellite connection

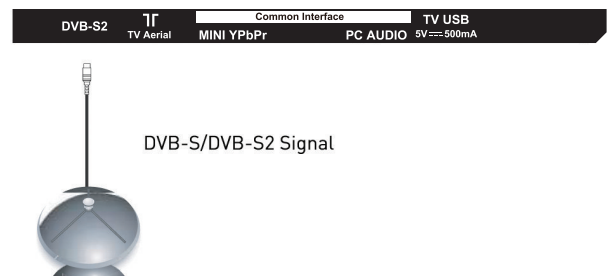

Connect the DVB-S/DVB-S2 signal to the SATELLITE LNB on the TV SET. Select the SATELLITE input source using the DVBS/DVBS2 button on the remote control.



**Note:** If there is no DVBS(S2) reception, please check whether there is any problem (such as a short-circuit) on the F-type connector, on the LNB cable, the multi-switch etc. of your satellite antenna system. In this case, please disconnect the TV set from the antenna system. If necessary, consult a qualified technician to solve the problem.

---

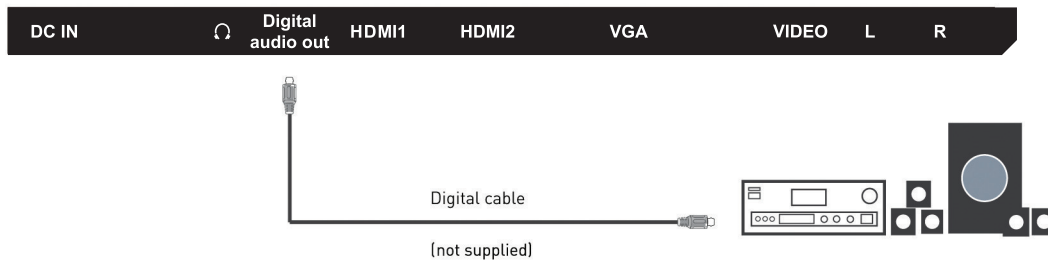
## Connecting a Digital Audio Receiver



For better sound quality, you may want to play the audio through your multi-channel audio receiver.

- Use an audiocable to connect the TV's Digital Audio out socket to an external audio receiver's audio optical input socket.
- Plug the connected devices into the mains socket
- Press the STANDBY button on the TV or the  button on the remote control
- Press the SOURCE button on the TV or the SOURCE button on the remote control to display the Source List. Use the   buttons to select any desired input source and then press the OK button to confirm.

**Note:** The TV's volume control will have no effect. You may control the audio level via the Audio Receiver.

## HDMI Connection

TV Back

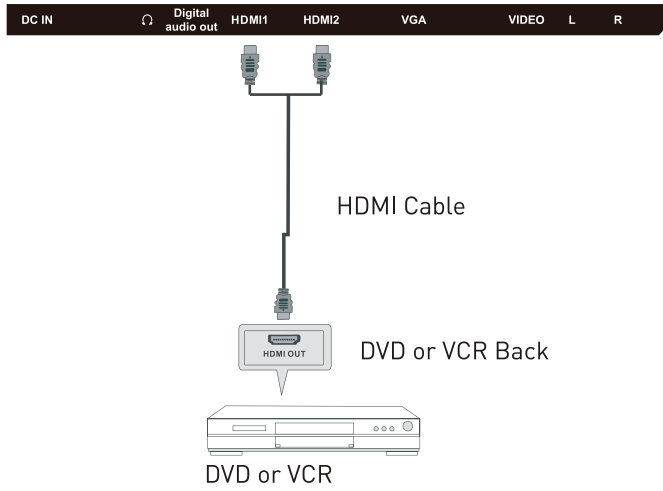

HDMI connection allows the user to transfer all audio/video/control signals through one cable only. These signals are transferred in digital.

## USB Connection

Put the USB flash drive in to the USB port, Select the USB channel source using the SOURCE button on the remote control. The maximum supported capacity of external storage devices (e.g. USB memory stick or USB hard disk) is 1TB. However, not all available storage media may be compatible.



## AV Connection

### TV Back

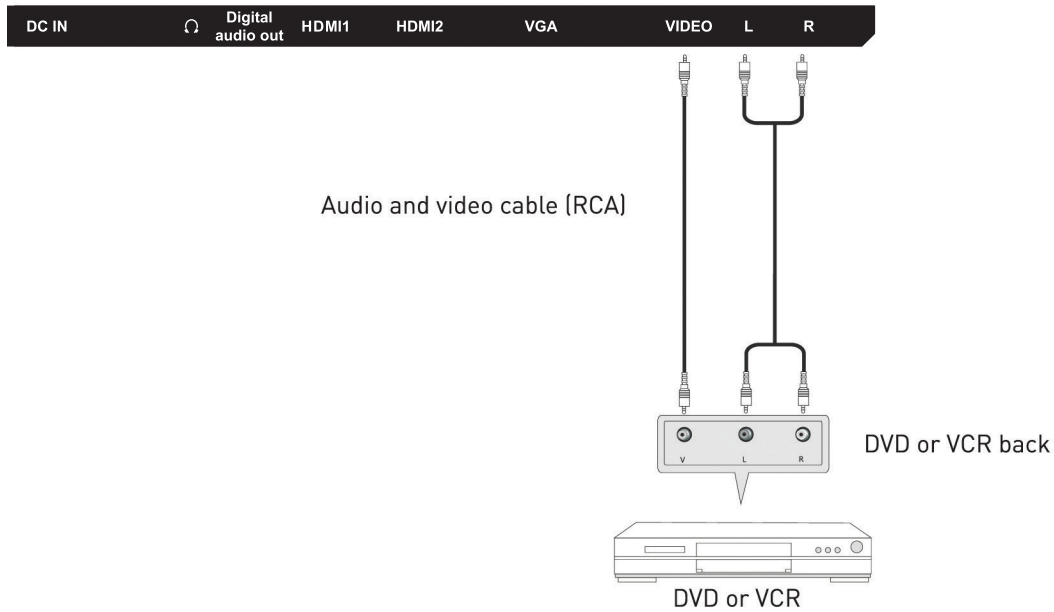

Connect the VIDEO and AUDIO output jack of the DVD or VCR to the VIDEO jacks on the TV set using a RCA cable (not supplied). Match the jack colors: Video is yellow, Audio left is white, and Audio right is red. Press the SOURCE button on the remote control and select the AV input source.

## YPbPr Connection

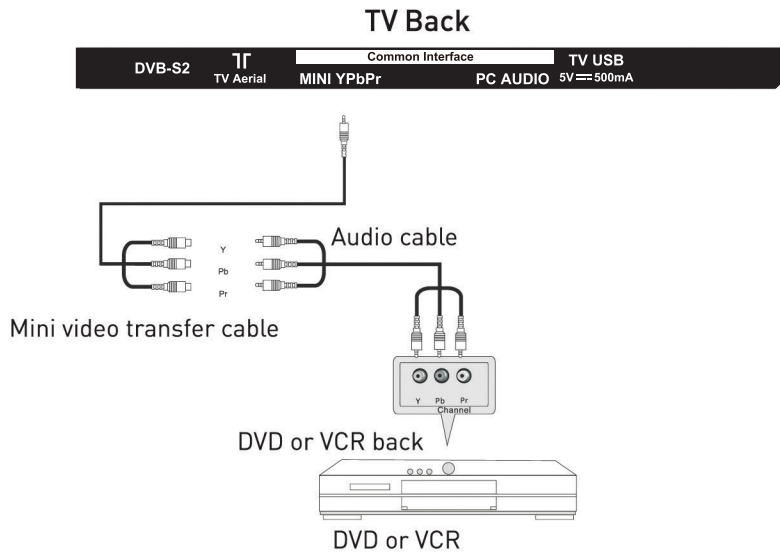

Connect the YPbPr output of the DVD or VCR to the YPbPr input on the TV set using the supplied YPbPr converter cable. Match the jacks colors : Y is green, Pb is blue, Pr is red. Press the SOURCE button on the remote control and select the YPbPr input source.



---

## First Time Installation

If this is the first time you are turning on the TV and there are no programs in the TV memory, the Quick Start menu will appear on the screen. There are 4 setups as follow:

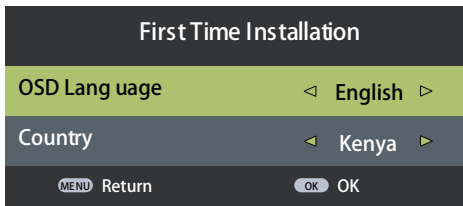

1

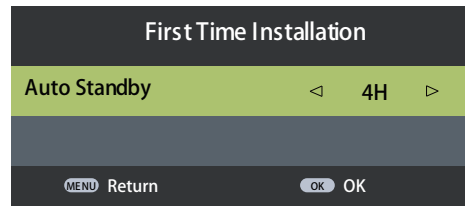

2

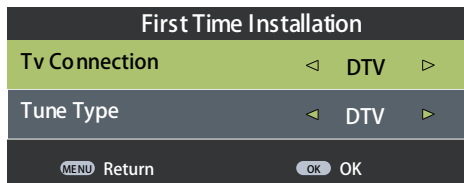

3

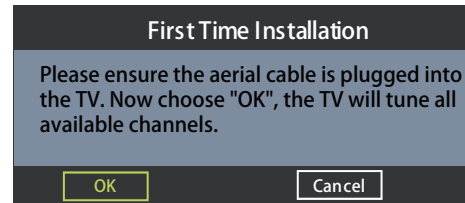

4

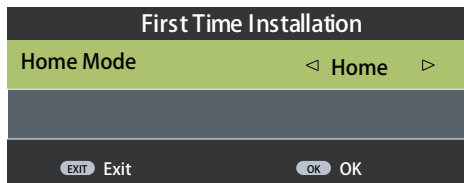

5

## Selecting the Input Source

1. Press the **Source** button on the TV or the **Source** button on the remote control to display the Input source list.
2. Press the **▲▼** buttons to select the input source that you want: DTV, Cable, Satellite, ATV, AV, YPbPr, PC, HDMI1, HDMI2, SMART,USB.
3. Press the **OK** button to confirm your selection. If you do not press the **OK** button to confirm, the TV will automatically confirm the selected input source within 4 seconds.

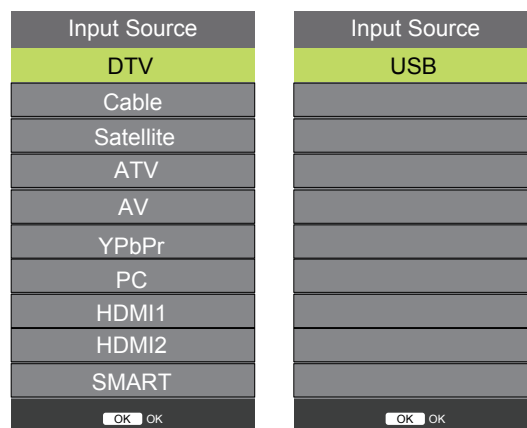

## Channel Selection

- Press the **CH+ / -** buttons on the TV or on the remote control repeatedly or the **0-9** buttons on the remote control to select the channel.



### Alternative

Press the **OK** button to enter the **Channel List**. Then use the **▲▼** buttons to highlight and select the channel.  
Press the **OK** button to view the selected channel.

- If a blocked channel is selected, the password screen will be displayed. Press the **0-9** buttons to enter the password, the channel will then be unlocked (refer to page 17 for details on LOCK ).

## Display Channel Information

- Press the **Info** button to view the current information.

## Volume Adjustment

- Press the **VOL+/-** button on the TV or on the remote control to adjust the volume.
- If you wish to switch the sound off, press the **Mute** button. Press the **Mute** button again or the **VOL+/-** button to resume audio listening.

# Picture Setting

Allows you to set your preferred picture mode.

1. Press the **Menu** button and then press the ◀▶ buttons to select the **PICTURE** menu.
2. Press the **OK** or ▼ buttons and then press the ▲▼ buttons to select the following picture options and then press the **OK** button.

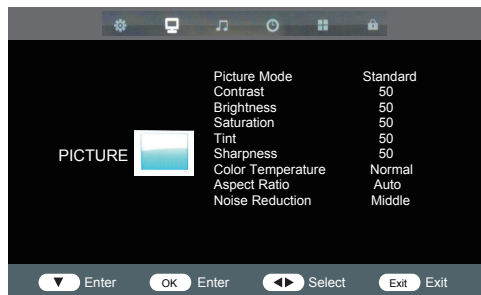

**Picture Mode** Press the ▲▼ buttons to cycle among picture mode: Dynamic / Standard / Mild / User .



### Alternative

You may press the **Picture** button once and then press the ◀▶ buttons to select the picture mode directly.

**Contrast** Press the ◀▶ buttons to adjust the difference between light and dark levels in the picture.(for User mode)

**Brightness** Press the ◀▶ buttons to increase or decreases the amount of white in the picture.(for User mode)

**Saturation** Press the ◀▶ buttons to increase or decreases the saturation.

**Tint** (For NTSC format) Press the ◀▶ buttons to adjust the balance between red and green levels. (Tint is only available for NTSC signal input via the SCART or AV IN.)

**Sharpness** Press the ◀▶ buttons to adjust the level of crispness in the edges between light and dark areas of the picture.(for User mode)

**Colour Temperature** Press the ▲▼ buttons to cycle among colour temperature: Normal / Cool / Warm.  
Adjusts the colour components independently to achieve a warm or cool.

- **Normal**
- **Cool:** Increases blue tint
- **Warm:** Increases red tint

**Aspect Ratio** Press the ▲▼ buttons to cycle among aspect ratio: 4:3 / 16:9 Auto / Zoom1 / Zoom2.



### Alternative

You may press the **Picture** button twice and then press the ◀▶ buttons to select the aspect ratio directly.

**Noise Reduction** Press the ◀▶ buttons to select to reduce the noise level of the connected device: Off / Low / Middle / High and then press the **Menu** button to confirm.

3. Press the **Menu** button to return to the previous menu. Press the **Exit** button to exit the menu.

# Sound Setting

Allows you to select an audio-enhancement technique.

1. Press the **Menu** button and then press the ◀▶ buttons to select the **SOUND** menu.
2. Press the **OK** or ▼ buttons and then press the ▲▼ buttons to select the following sound options and then press the **OK** button.



---

**Sound Mode** Press the ▲▼ buttons to select an audio-enhancement technique:  
Standard / Music / Movie / Sports/ User.



## Alternative

You may press the **Sound** button once and then press the ◀▶ buttons to select the sound mode.

---

**Balance** Press the ◀▶ buttons to adjust the relative volume of the speakers in a multiple speaker system.

---

**Auto Volume** This feature automatically adjusts the audio level when the TV is turned on. This function is activated by selecting "Off".

---

**Surround Sound** Turn on/off the surround sound function by selecting "Surround" or "Off".

---

**SPDIF Mode** Select the spdif mode for the TV from off, PCM and Auto.

3. Press the **Menu** button to return to the previous menu. Press the **Exit** button to exit the menu.

## Speaker Sound Output Selection (Antenna Mode)

While watching a DTV programme, you can press the **Sound** button to display the audio language list (only applicable when the TV programme has this feature).

Press the ▲▼ buttons to select an audio language or audio format if available and then press the ◀▶ buttons to select sound track between Left, Right and Stereo. Press the **OK** button to confirm and exit.

---

## Channel Setting (TV, DTV or Radio Mode)

Allows you to set up a variety of channel options.

1. Press the **Menu** button and then press the ◀ ▶ buttons to select the **CHANNEL** menu.
2. Press the **OK** and then press the ▲ ▼ buttons to select the following channel options and then press the **OK** button.



---

## Auto Tuning

1. Press the ▲ ▼ buttons to Auto Tuning then press the **OK** button to confirm.
2. In the Auto Tuning menu there are 2 options for you to select from: Tune Type and Country.
3. Press the Menu button to return back to the main menu.
4. Press the Exit button to exit the menu.

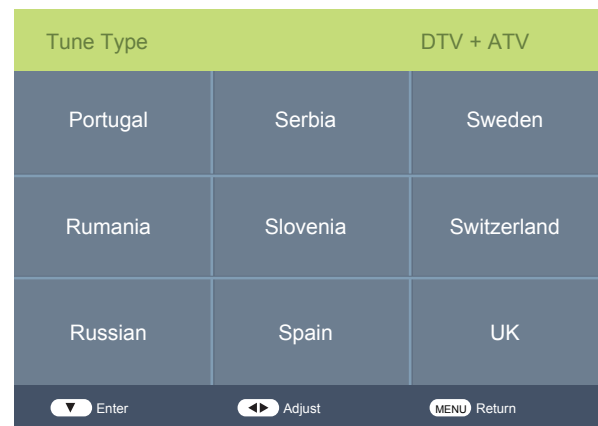

---

## Smart Antenna

For the smart antenna to work, 5V antenna power must be set to ON.  
If you have no channels check this.

---

---

# Channel Setting (TV, DTV or Radio Mode)

## DVB-T Manual Tuning

How to search Digital channels manually.

1. Select DVB-T Manual Tuning, press the **OK** button to confirm.
2. Select a channel number by pressing the **▶** button or by using the number buttons on the remote control. The Strength and Quality of the signal indication bars are below.
3. Select **OK** to begin the search.
4. To exit the tuning menu press EXIT.



---

## ATV Manual Tuning

To search analogue channel by entering parameters manually.

1. Press the **▲▼** buttons to ATV Manual Tuning then press the **OK** button to confirm.
2. Select ATV manual search item to enter air channel manual search in ATV source and the user operation interface as following.

<b>Storage To 1</b>	Press the <b>◀▶</b> buttons to change the numbered location of the found channel.
<b>Sound System</b>	Selects the sound system: BG / DK / I / L.
<b>Color System</b>	Selects the color system: SECAM / PAL / NTSC.
<b>Current Channe</b>	Displays the current channel number.
<b>Search</b>	Press the <b>◀▶</b> buttons to start the manual tuning.
<b>Fine-Tune</b>	Press the <b>◀▶</b> buttons to make manual fine tuning adjustments.

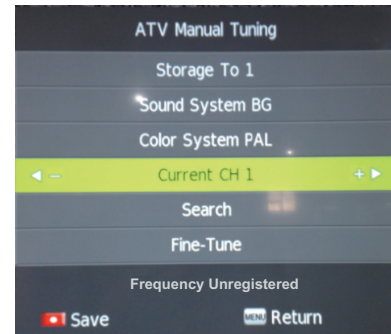

3. Press the **Menu** button to return back to the main menu.
4. Press the **Exit** button to exit the menu.

# Channel Setting (TV, DTV or Radio Mode)

## Satellite Edit

1. If you do not have a fixed dish aligned to Astra 19.2E fitted with universal LNB you will need to use this section.
2. If you have a fixed Dish aligned to a different Satellite or with a different LNB you will need to use this section.
3. If you have a motorised Dish with a DiSEqC rotator and wish to tune more than one satellite you will need this section.
4. If you are on a DiSEqC switch system you will need this section.

The first 2 installations can be done by most people so long as you know what satellite your dish is aligned with and what type of LNB it is fitted with.

Installation of 3 & 4 require an experienced user or engineer.

### To set a different Satellite or LNB

Select Satellite mode, press MENU key, navigate down to the Satellite Edit, press OK. You will see the Satellite Edit menu

Satellite	
(01/59) Ku_HOTBIRD 13B,13C,13D	013.0 E
(02/59) Ku_ASTR A 1N,1KR,1L,1M	019.2 E
(03/59) Ku_ASTR A 2E,2F,2G	028.2 E
(04/59) Ku_ASTR A 3B	023.5 E
(05/59) Ku_NILESAT 101, 10	007.0 W
(06/59) Ku_EUTELSAT W3A	007.0 E
(07/59) Ku_EUTELSAT W1	010.0 E
(08/59) Ku_BADR-2,3,4/EURO	026.0 E
(09/59) Ku_EUTELSAT SESAT	036.0 E
(10/59) Ku_EUTELSAT 16A	016.0 E

Buttons: Delete Satellite, Add Satellite, Select, OK, Return

## Satellite List

The Satellite list displays the satellite names.

Satellite	
(01/59) Ku_HOTBIRD 13B,13C,13D	013.0 E
(02/59) Ku_ASTR A 1N,1KR,1L,1M	019.2 E
(03/59) Ku_ASTR A 2E,2F,2G	028.2 E
(04/59) Ku_ASTR A 3B	023.5 E
(05/59) Ku_NILESAT 101, 10	007.0 W
(06/59) Ku_EUTELSAT W3A	007.0 E
(07/59) Ku_EUTELSAT W1	010.0 E
(08/59) Ku_BADR-2,3,4/EURO	026.0 E
(09/59) Ku_EUTELSAT SESAT	036.0 E
(10/59) Ku_EUTELSAT 16A	016.0 E

Buttons: Delete Satellite, Add Satellite, Select, OK, Return

No. The current list number of the selected satellite Satellite name. The No. cannot be edited.

Satellite name: Press the OK button to open the edit menu as below image

Satellite	
Satellite Name	HOTBIRD 13B,13...
Orbit Position	013.0 E
LNB Type	Universal
DiSEqC1.0	Off
DiSEqC1.1	Off
Tone 22KHz	AUTO
Transponder	
Unicable Setting	Off
Motor	Off
Band	Ku

Input number

Buttons: Select, Return

Press the number buttons on the remote to edit the name.

**Orbit Position:** Press the number buttons to edit longitude angle and press LEFT /RIGHT button to change Longitude direction

**LNB Type:** LNB Frequency

**DiSEqC1.0:** 4 select 1 switch ( Require the user device support DiSEqC 1.0 protocol). Press ◀▶ to select LNB1/ LNB2/ LNB3/LNB4/None.

**LNB1/LNB2/LNB3/LNB4:** Corresponding to a satellite , After selecting the corresponding list will appear in the satellite list.

**DiSEqC 1.1:** 16 select 1 switch ( Require the user device support DiSEqC1 .0 protocol) Equipment needs support DiSEqC 1.1 protocol, Most control 16↑LNB. Press ◀▶ to select LNB1~LBN16/None.

**LNB 1-LNB 16:** Corresponding to a satellite, After selecting the corresponding list will appear in the satellite list.

**Tone 22KHz:** The level of the L0 switch / DS switch ( Require the user to have installed 22KHzSatellite signal switch). Press ◀▶ to select Auto/On/Off.

**Transponder:** Press OK button to edit the transponder.

Satellite	
(01/117)	10729V22000
(02/117)	10744H22000
(03/117)	10758V22000
(04/117)	10773H22000
(05/117)	10788V22000
(06/117)	10803H22000
(07/117)	10818V22000
(08/117)	10832H22000
(09/117)	10847V22000
(10/117)	10876V22000

Buttons: Delete Transponder, Add Transponder, Select, OK, Return

# Channel Setting (TV, DTV or Radio Mode)

## Edit Transponder menu

Press OK button to edit the Transponder

Satellite	
Frequency(MHz)	10729
Symbol Rate(Ksym/s)	22000
Polarity	Vertical Pos.

**Frequency:** Set the downlink frequency.

**Symbol (ks/s):** Set the Symbol Rate.

**Polarity:** Set the polarity (horizontal or vertical).

## Delete Transponder

Press the RED button to delete the Transponder.

## Add Transponder

Press the Yellow button to delete the Transponder.

Satellite	
Frequency(MHz)	0
Symbol Rate(Ksym/s)	0
Polarity	Horizontal Pos.

**Frequency:** Set the downlink frequency.

**Symbol (ks/s):** Set the Symbol Rate.

**Polarity:** Set the polarity (horizontal or vertical).

**Motor:** Control of multi-satellite polar (Require the user device support DiSEqC1.2 or DiSEqC1.3 protocol), Left and right buttons to select DiSEqC1.2/ DiSEqC1.3/None.

DiSEqC1.2: DiSEqC1.2 Protocol selection

DiSEqC1.3: DiSEqC1.3 Protocol selection

For Motor definite "DiSEqC1.2", Operating Instructions:

Press RED button to enter "Set Limit" menu.

Press OK button to enter Set Position menu.

**Band :** Band selection,press LEFT/RIGHT button to select.

Press RED button to delete a Satellite

Press Yellow button to Add a new Satellite

Satellite	
Satellite Name	ASTRA 1N,1KR,...
Orbit Position	019.2 E
LNB Type	Universal
DiSEqC1.0	LNB 1
DiSEqC1.1	Off
Tone 22KHz	Off
TransPonder	
Unicable Setting	Off
Motor	Off
Band	Ku
Select      MENU Return	



---

## Channel Setting (TV, DTV or Radio Mode)

### Programme Edit

Use up/down keys to select program edit. Press **OK** to enter the menu.

### Delete

Press the **RED** button to delete the highlighted channel, a red circle will appear next to the channel name.

Press the **RED** button again to confirm delete.

Press the **MENU** to return to the main menu.

### Move

Press up/down to select the channel, press yellow button to enter the move mode, then press up/down to move the channel location, press yellow button again or press **OK** to confirm.

Press **MENU** to return to the main menu.

### Skip

Press up/down to select the channel you wish to skip.

press the **BLUE** button, a logo will appear next to the channel name and the channel will be skipped when you scroll through the channels.

Press the **BLUE** button again on the highlighted channel to disable the skip function. Press **MENU** to return to the main menu.

### Signal Information

Only available in DTV mode.

### CI Information

When insert CI Module, display CI Information.

### Software Update(USB)

1. Download the software to the usb device, then insert the usb device to the unit.
2. Press the menu button to select the CHANNEL menu.
3. Press the left/right buttons to select Software Update(USB) and then press the **OK** button to update software.
4. When the updating is completed, the unit will be reset to standby mode.

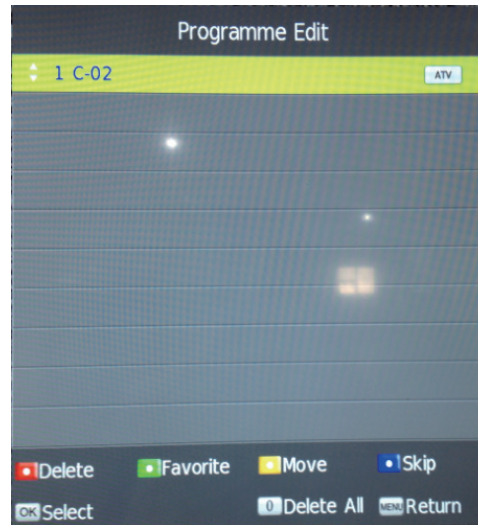

---

# Lock Setting

1. Press the **Menu** button and then press the **▲▼** buttons to select the Lock menu.
2. Press the **OK** or **▼** buttons and then press the **▲▼** buttons to select the following feature options and then press the **OK** button.



---

## Lock System

1. Press the **▲▼** buttons to Lock System then press the **OK** button to confirm.
2. Use the **0-9** buttons to input a 4-digit password to enter the **LOCK** menu and then press the **OK** button to turn the Lock System **On**.



- The default password is "0000".
- If you change the password, be sure to remember the new password! If you forget the new password, press the master password "8899".

**Set Password:** If you had already changed the password, enter the current password.

**Block Program:** This feature is available only for digital TV and the tuned-in channel must support it.

**Parental Guidance:** Off: turn off Parental Lock  
4-18: turn on Parental Lock and set the age level that are permitted to watch the program.

**Key Lock:** Press the **▲▼** buttons to select the "Key Lock" option and then press **◀▶** to choose between the options ON or OFF. After selecting ON, the front panel buttons TV/AV/Menu/CH+/CH-/VOL+/VOL- of the device will be locked.

**Hotel Mode:** Enter the Hotel Setting menu.

3. Press the **Menu** button to return back to the main menu.
  4. Press the **Exit** button to exit the menu.
-

---

# Lock Setting

## Lock System

Press the up/down buttons to select the “Lock System” option and then press the right button to choose between ON and OFF.

## Set Password

Press the up/down buttons to select the “Set Password” option and then press **OK** to enable the menu.

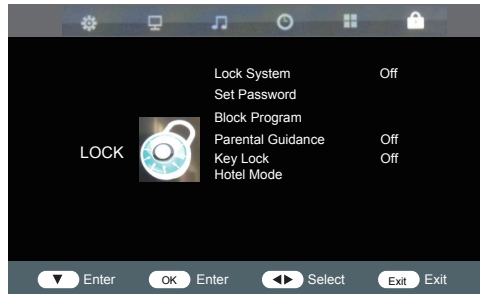

## Block Program

Press up/down buttons to select the “Block Program”.

## Parental Guidance

Press the up/down buttons to select the “Parental Guidance” option and then press the right button to choose between ON and OFF.

## Key Lock

Press up/down buttons to select the “Key Lock ”.

## Hotel Mode

Press the up/down buttons to select the “Hotel Mode” option.

---

# Time Setting

1. Press the **Menu** button and then press the **▲▼** buttons to select the Time menu.
2. Press the **OK** or **▼** buttons and then press the **▲▼** buttons to select the following feature options and then press the **OK** button.



---

## Clock

Press the **OK** button to set date and time.

## Off Time

Press the **OK** button to set off time.

## On Time

Press the **OK** button to set on time.

## Sleep Timer

The sleep timer automatically switches the TV to standby after the preset time has elapsed. The clock will be set automatically when receiving a digital signal. Time must be set before using Sleep Timer function.

Press up/down buttons to select a period of time after which the TV automatically switches to standby mode: OFF/10/20/.../180/240 min and then press the **OK** button to confirm. The timer begins to count down from the number of minutes selected.

## Auto Standby

The unit will automatically switch to standby mode 3/4/5/Off hours after the last time the remote control was used. A reminder screen will pop up and count down before the unit switches to standby mode. If you want to operate the TV for a long period of time, turn off the auto standby function by selecting Off.

## Time Zone

When you select a Time Zone city, the TV time is set by the time off set information based on Time Zone and GMT which is received with the broadcast signal and the time is set automatically by a digital signal.

Press the up/down/left/right buttons to select the desired time zone city and then press the **OK** button to confirm. (DTV mode)

## OSD Timer

Press up/down buttons to select the display time of the on-screen menu: 5s/10s/15s/20s/25s/30s/Off and then press the **OK** button to confirm.

---

# Option Setting

1. Press the **Menu** button and then press the **▲▼** buttons to select the Option menu.
2. Press the **OK** or **▼** buttons and then press the **▲▼** buttons to select the following feature options and then press the **OK** button.



---

## OSD Language

Allows you to select the on screen display menu language.

## Audio Languages

Select the audio languages. The availability of this function depends on the tuned-in channel. (can only be selected in DTV mode)

## Subtitle Language

Select the subtitle language. The availability of this function depends on the tuned-in channel. (can only be selected in DTV mode)

## Hearing Impaired

Allows you to show more information in subtitles for the hearing-impaired in some programmes (can only be selected in DTV mode)

## PVR File System

## Reset

Restores all settings to the factory defaults.

## First Time Installation

This option allows you to reset the TV to the default factory setting. Once activated the TV will go to standby mode.

## Home Mode

Press left/right buttons to select Max Economy/Max Brightness/Home.

## Blue Screen

Press left/right buttons to select ON or OFF

# Connecting a USB Storage Device

1. Switch off the TV before connecting any USB storage device.
2. Connect your USB storage device to the USB port of your TV.
3. Plug the connected devices into the mains socket
4. Press the **POWER** button on of the TV or the **⏻** button on the remote control to turn on your TV.
5. Press the **SOURCE** button on the TV or the **SOURCE** button on the remote control to display the Source List. Use the **▲▼** buttons to select **USB** and then press the **OK** button to confirm.

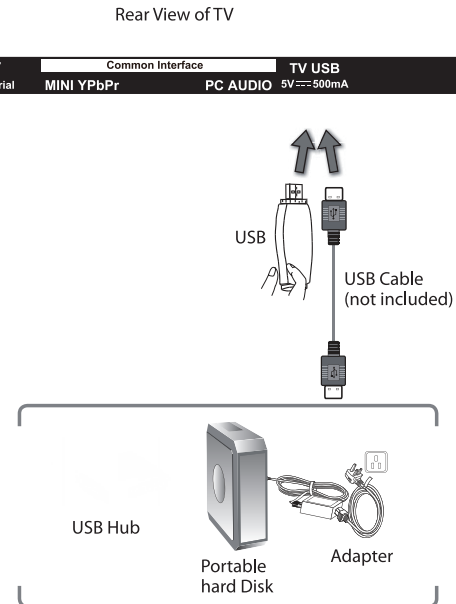

- If a hard disk is used, make sure its mains adapter is connected to the mains supply.
- If a USB hub is used, make sure its mains adapter is connected to the mains supply as the total current consumption may exceed 500mA.
- The maximum supported storage space of the hard disk is 1 TB.
- The file system only supports HiSpeed FS, FAT16, FAT32, NTFS formats (NTFS Compressed files are not supported).
- If you want to store the video streaming of a DTV programme, the transfer rate of the USB storage device must not be less than 5MB/s, otherwise the picture and sound of the programme will be affected and a warning statement will be shown on the screen. If this happens, please upgrade your USB storage device.
- The TV screen will be blank temporarily as it will take time to start up and stabilise the connected hard disk. This is normal and the starting time may vary depending on the brand and the memory size of the connected hard disk.
- Disconnect the USB storage device if it is not in use.
- USB output: DC 5V  $\overline{=}$  500mA

# Multimedia Operation

## Basic Operation

1. Press the SOURCE button on the remote control to display the input source menu, select the USB source with the up/down buttons and press the **OK** button to enter the Multimedia menu below.



2. Press left/right buttons to select the files on the USB device (PHOTO, MUSIC, MOVIE, TEXT) to view or play.

Return to main menu

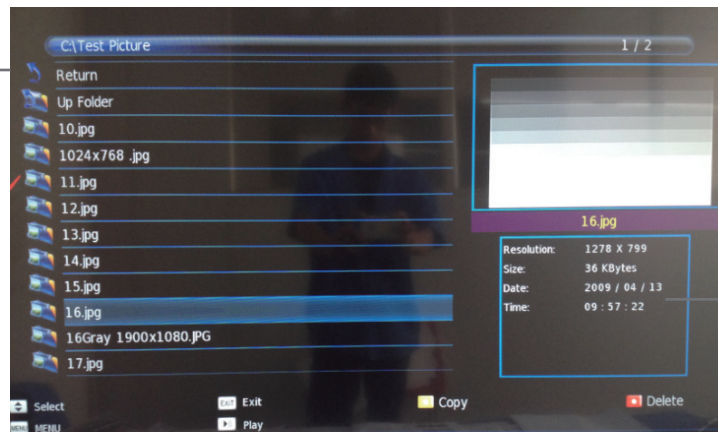

Preview

File Information

Press the up/down/left/right buttons to select and the **OK** button to activate the file or open folder. Press **▶▶** button to play the files in full screen mode. When in full screen mode press the **OK** button to show the navigation option menu on the bottom of the screen or press **■** stop button to return to files.

---

## 1.Photo

### Photo viewing

Press left/right buttons to select the option on the menu, and press the **OK** button to activate.

**Play:** Play the photo.

**Prev./Next:** Go to a picture/Go to the next picture.

**Stop:** Stop auto turning pages.

**Repeat:** Select the repeat mode from Repeat All, Repeat One, Repeat None.

**Music:** Play/Pause the background music of your choice.

**Playlist:** Display the playlist on the screen and select the photo of your choice.

**Info:** Display the information of the file.

**Rotate:** Rotate the photo clockwise/counterclockwise.

**Zoom In/Out:** Zoom In/Out of your photos.

**Move view:** Move the photo in Zoom out mode.

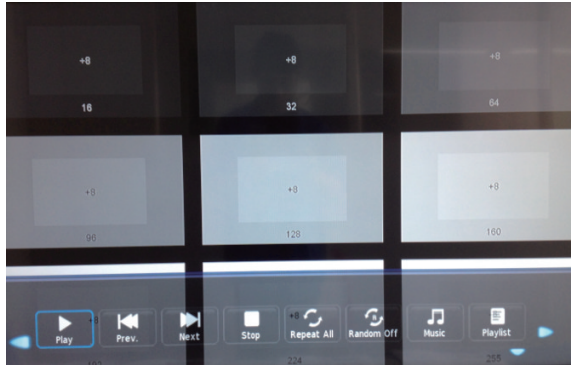

---

## 2.Music

### Listen to music

Press left/right buttons to select the option on the menu, and press the **OK** button to activate.

**Play:** Play the music.

**FB:** Retreat quickly.

**FF:** Fast forward.

**Prev./Next:** Go to a song/Turn to the next song.

**Stop:** Stop playing.

**Repeat:** Select the repeat mode from Repeat All, Repeat One, Repeat None.

**Play List:** Display the playlist on the screen.

**Info.:** Display the information of the music file.

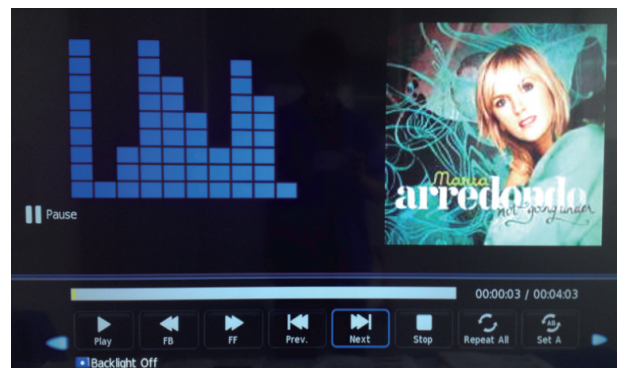



---

## 3.Movie

### Watch a film

Press left/right buttons to select the option on the menu,and press the **OK** button to activate.

**Play:** Play the movie.

**FB:** Retreat quickly.

**FF:** Fast forward.

**Prev./Next:** Go to a video/Turn to the next video.

**Stop:** Stop playing.

**Repeat:** Select the repeat mode from Repeat All, Repeat One,Repeat None.

**Aspect Ratio:** Select the aspect ratio of the on screen display.

**Move View:** Moves the enlarged picture area.

---



## 4.Text

### View text files

Press left/right buttons to select the option on the menu,and press the **OK** button to activate.

**Prev/Next page:** Turn to previous/next page of the text.

**Prev./Next:** Turn to previous/next file.

**Stop:** Stop auto turning pages.

**Music:** Play/pause the background music of your choice.

**Playlist:** Display the playlist on the screen.

**Info:** Display the information of the text file.

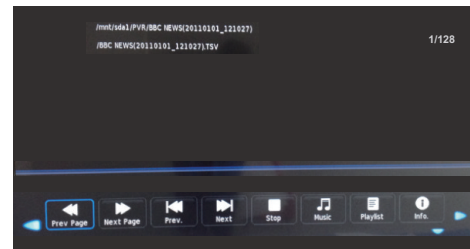

## TROUBLE SHOOTING GUIDE

To assist in locating possible faults use the help guide below.

SYMPTOM	SOLUTION
No Picture	Check that the TV is correctly plugged in. Check that the TV is connected to a suitable power source. Check the electrical supply is turned on.
No Picture	Ensure that the TV is powered on. Check that the cables are fitted securely. Ensure the aerial and/or external sources are connected. Press the SOURCE button to change the source. Turn the TV on or off.
No Sound	Press the MUTE button and check if Mute mode is set. Switch to another channel and see if the same problem occurs. Press V+ button to see if the problem can be solved.
No picture on some channels	Check that correct channel is selected. Adjust the antenna.
No colour on some channels (black & white)	Check if the same problem exists on other channels. Ensure the correct picture settings are selected.
Noisy, Snowy, Ghosting picture.	Check the antenna is connected correctly. Check that the antenna is in good condition. Try moving the antenna.
Will not accept disc	DVD not selected. Select DVD mode with SOURCE button.
Screen shows "NO DISC"	Disc placed incorrectly. Disc must have mirror side facing you if single side.
	Disc damaged or dirty. Inspect disc. If damaged you must discard. If dirty see "Disc care" page.
Picture "Freezes" or breaks up	Disc damaged or dirty, See "Disc care" page
Certain disc functions not working.	Disc may not support required feature. Read disc information.

If none of the suggestions seem to work, try switching your TV off and then on again. If this does not work contact our technical helpline.

NOTE: The TV must only be repaired by a qualified registered service person. Never attempt to remove the back cover as the TV has dangerous voltages inside that may cause fatality or fire.



DVD-Signal: NTSC, PAL (Regionalcode 2)



**Caution:**

This unit is a class 1 laser product. However this unit uses a visible laser beam which could cause hazardous radiation exposure if directed. Be sure to operate the player correctly as instructed.

## TECHNICAL SPECIFICATIONS

Specifications of the TV that you have just purchased may vary from the information in this table due to technical innovations.

### TV Specifications

TV System	PAL/BG/DK/ I
Audio System	BG/DK/I
Screen size	22" (Diagonal)
Resolution	1920 x 1080 Pixels (RGB)
Aerial input	75 Ohm (unbalanced)
Audio output power	2 x 3W
Power requirements	12V  3A
Power consumption	17W
Standby power consumption	<0.5W
Weight	2.4kg

## Remote control specifications

Type	Infrared
Control distance	5m
Control angle	30 degrees (Horizontal)
Batteries	2 x 1.5V, Size AAA
Dimensions	48 x 193 x 20mm
Weight	120g (without batteries)

## Wall Mounting

1. The stand base and stand stem must be removed.
2. Please follow the instructions of how to apply the stand (included in the gift box), if you have already attached the TV stand read the instructions in reverse order to detach.
3. Be sure the stand stem is removed (unscrew 4 screws at the stem).
4. Use four machine screws to mount the TV on the bracket.

This unit is VESA-Compliant and designed to be wall mounted with a VESA-Compliant 100mm x 100 mm mounting kit. Mount this unit according to the instructions of the wall bracket (not supplied)

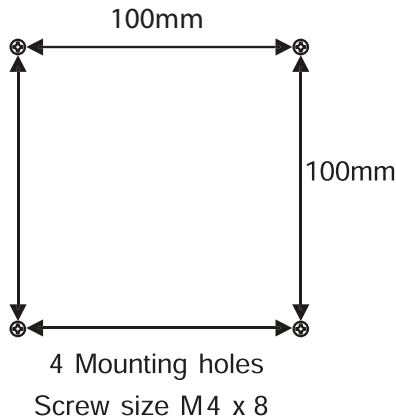

## Waste Electrical Recycling

### Correct disposal of Product

 This sign indicates that this product may not be disposed of with your regular household waste. The recycling and separate collection of such products is your responsibility. Please drop off the above mentioned waste at a designated place for recycling waste electrical and electronic equipment. If you do not know where to drop off your waste equipment for recycling, please contact your local city office or household waste collection service.

 The crossed out wheeled dust bin symbol indicates that batteries and /or accumulators must be collected and disposed of separately from household waste.

**Hg Cd Pb**  
 If the battery or accumulator contains more than the specified values of lead (Pb), mercury (Hg), and/or cadmium (Cd) defined in the Battery Directive (2006/66/EC), then the chemicals Hg Cd Pb symbols for lead(Pb), mercury (Hg) and/or cadmium (Cd) will appear below the crossed out wheeled dust bin symbol.

By participating in separate collection of batteries, you will help to assure the proper disposal of products and batteries thus help to prevent potential negative consequences for the environment and human health.

For more detailed information about the collection and recycling programmes available in your country, please contact your local city office or the shop where you purchased this product.

 This appliance complies with European Safety and Electrical directives.  
It fulfills the following EU regulations:

En55013:2001+A1:2003+A2:2006  
EN55020 2007  
EN61000-3-22006 EN61000-3-3:1995+A1:2001+A2:2005  
EN55022:2006(CLASS-A)  
EN55024:1998+A1:2001+A2:2003



